



“Made in Fujitec”

Fujitec is Creating and Leading the
New Global Standard for Elevators



By manufacturing safe and reliable elevators in-house, we are building trust with people around the world.

Fujitec's "Global Common Components" are used in the ZEXIA-D brand. The quality of components, such as traction machines, elevator controllers, and operating fixtures, is controlled through Fujitec's integrated system of global quality management. Elevators with the same high quality will be provided by Fujitec's global supply chain under the concept of "Made in Fujitec."



Excellent Performance

The permanent magnetic synchronous gearless motors, which have been designed and developed by Fujitec, provide the utmost reliability and excellent driving performance. These motors reflect 75 years of accumulated know-how through our technological achievements in elevator manufacturing, which spans from product designing to fabrication.



Reliable Operation

Since all control-related components, ranging from control circuits to inverters, were independently developed by Fujitec, highly reliable elevator operation is established. In the event of an elevator malfunction, the elevator control system assembled with our components immediately detects the malfunction and maintains efficient and stable operation.

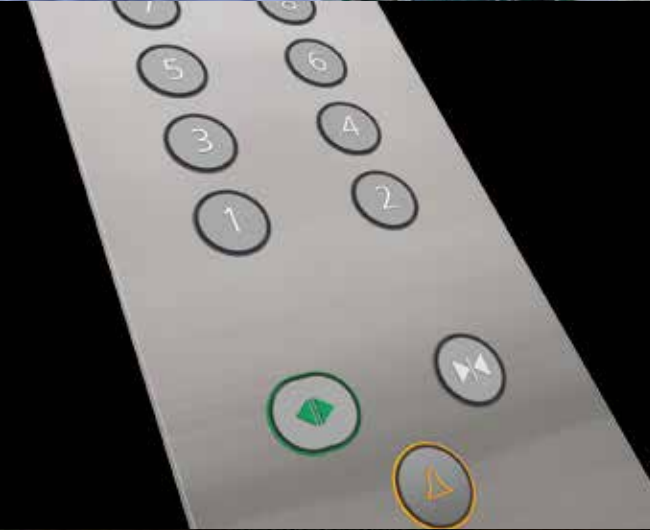

Universal Design

Under our universal designs, aesthetically refined buttons, displays, etc. on elevator operating fixtures are highly visible. Passengers will have a superb and comfortable riding experience.



Styles

Various decoration styles for the elevator interior and landing floors are offered by Fujitec. Customers can select the most suitable decorative materials for car panels, car ceilings, car floorings, car operating boards and landing fixtures.

CONTENTS

Excellent Performance	05
Reliable Operation	06
Universal Design	07
Styles	09
Systems & Functions	25
Planning	29
Power Supply Data	32
Relevant Dimensions	33
Work Done by Others	35



Excellent Performance

Gearless Traction Machine with Permanent Magnetic Synchronous Motor

The gearless traction machine with a permanent magnet synchronous motor assure high riding comfort quality and low power consumption. This newly adopted technology reduces the weight and size of a traction machine, because gears are no longer required for elevator speed control.

A Small Machine Results in Space Saving

The machine room space required by our ZEXIA-D elevators is 60% smaller than that of conventional elevators. This remarkable feature results in a reduction of building construction costs and increases usable space in the building.

Ultra-Slim Door Operator with Permanent Magnetic Synchronous Motor

Fujitec's new door operators have adopted a permanent magnetic synchronous motor which doesn't have any gears for door speed control. The use of this kind of motor reduces the size of a door operator and achieves smooth and precise door operation.

These new door operators consume approximately **35%** less power than the conventional ones.

In addition, ZEXIA-D is small machines require less motor capacity and power consumption compared to conventional elevators. The differences are shown below.

Given elevator operating conditions:
 The maximum number of elevator operations per day: 600 times
 The travel distance in a single operation: 30 meters
 The rated speed: 1.0 meter per second
 The rated load: 1200kgs.

ZEXIA-D Elevator(PMGL)	8.5kW
Conventional Elevator(ACGD)	9.0kW

Required Motor Capacity

Electrical Usage per Month**

ZEXIA-D Elevator(PMGL)	646kW/month*	22% Energy saving
Conventional Elevator(ACGD)	827kWh/ month	

*1 : The number of days in a single month is assumed as 30 days.
 *2 : Electrical usage might vary depending on site conditions.

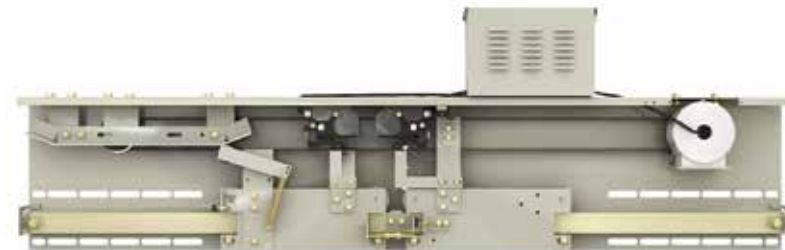
Distributed Control System

COP: Control Panel
 COB: Car Operating Board
 MIC: Microcomputer
 IN: Hall Indicator

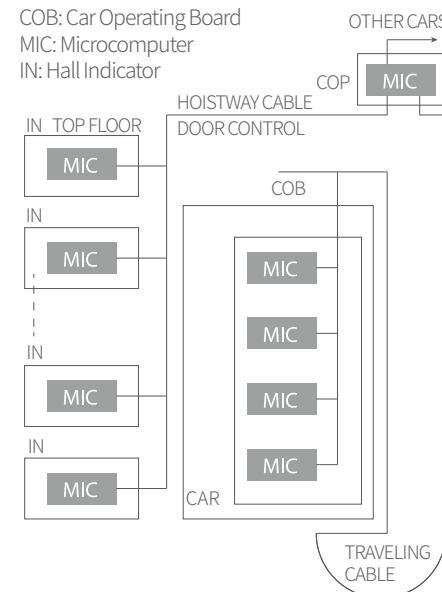

- A 32-bit data bus provides high-speed and high-precision data transmission of input-output command signals between each microprocessor located in control panels, hall-call / car-call buttons, hall indicators and hall lanterns.
- High-speed data transmis with multiple protocols enables large-scale data processing at ten times the normal speed. This also improves the ability to monitor elevator running speed, landing precision and operating reliability as well as input-output command signals of car operating fixtures and operation indicators.
- The bus system is employed for data transmission between microcomputers located in every hall-call fixture, car operating board, and control panel. This bus system has strong protection against signal interference and has system-extending capability.



An elevator operation system with multiple microcomputers makes maximum use of the "Distributed Control System." Hall indicators, car operating boards, and control panels incorporate high-performance microcomputers. These independent microcomputers analyze elevator operating conditions utilizing self-diagnostic functions and implement immediate control of elevator operations. Also, data transmission buses among microcomputers increase data processing capability.

Reliable Operation



Car Door Anti Stripping Device

It can prevent passengers from falling into the hoistway when the door is opened in the non- unlocking area, and further ensure the safety of elevator passengers.



Impact Resistant Door System

The impact resistance of the landing door system is further strengthened, and the risk of falling into the hoistway caused by the impact of the landing door system is effectively prevented, further ensuring the safety of elevator related personnel.



Unintended Car Movement Protection(UCMP)

A safety- purpose control circuit independent of the elevator operating system detects unintended movement of a car and prevents the car from moving from the floor with its doors open. This function improves passenger safety.

FLEX-NX series - Elevator Group Supervisory Control System -

Fujitec has adopted the "Virtual Passenger Optimization Method" as a new elevator group control system.

This system controls elevator group operation by virtually calculating passenger waiting time in advance based on past accumulated data, such as passenger travel patterns and passenger volume at each floor. Also, this method comprehensively calculates passenger waiting time based on extrapolated data of probable future passengers, how many passengers will come to a certain floor when a hall call is registered and/or how many passengers will come to a certain floor when no hall call is registered. This comprehensive analysis reflects whole building traffic conditions for efficient elevator operation control as well as reducing daily passenger waiting time by up to 10%.

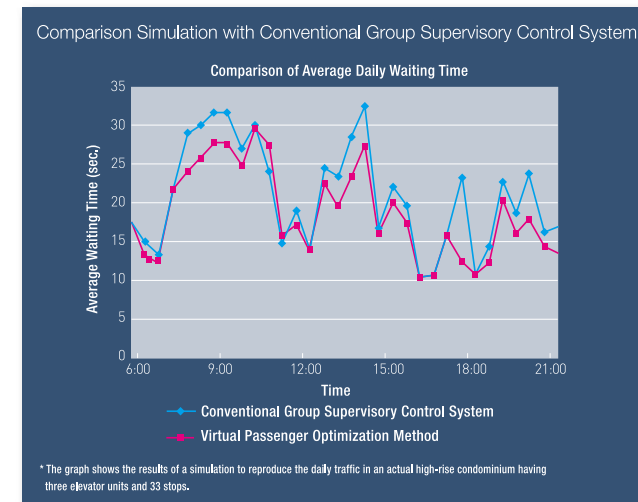



Fujitec's new global-standard operating fixtures reflect the latest in Human Engineering technology. Fixture buttons with clearly visible lettering function as the man-machine interface. Passengers can register their destination in a visually intuitive manner.

23569 23569

The newly adopted lettering for the operating fixture buttons is highly visible at wider angles than the former one. The lettering is highly visible, so that passengers anywhere under any lighting conditions in the car can see and easily read the letters and the numbers. Fujitec's uniquely designed operating fixtures function as a friendly interface between the passengers and the elevators.

The eye-catching green door open button can prevent passengers from mistaking the door open button for other buttons.

The emergency call button is located about 900mm from floor level allowing children and physically impaired to use in case of emergency.

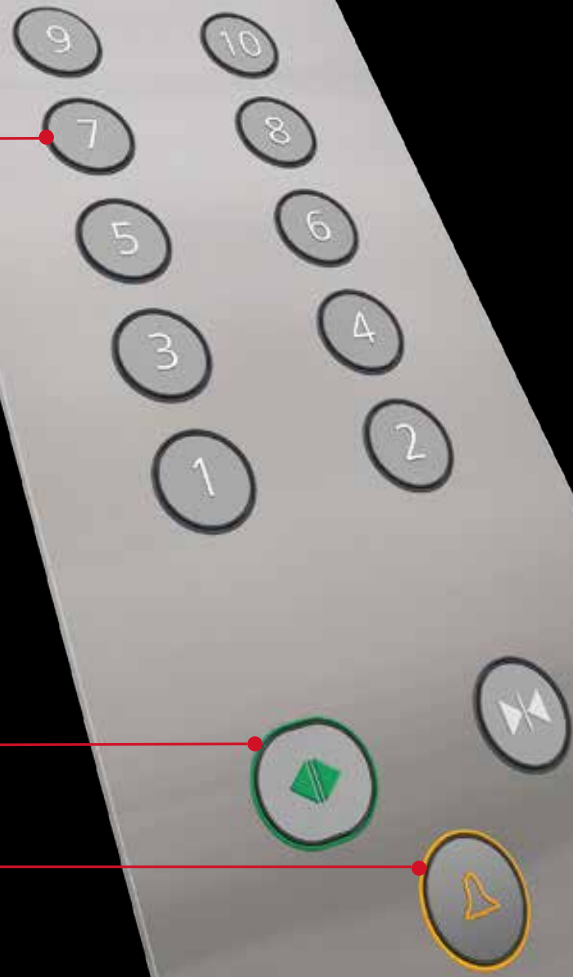

Night-Time Self-Checking Operation

- A safety enhancement for increased reliability -

Mechanical brake conditions are automatically checked by moving the elevator during the night time while not receiving any car and hall calls.

This night-time self-checking operation increases passenger safety and contributes to a high after-sales product quality.

IONFUL

- Plasmacluster™ Ion Generating Device -

(Optional Specification)

Fujitec is the leading elevator company to have installed a Plasmacluster Ion generating device in an elevator. This device built in a car's ventilating unit disinfects airborne mold, bacteria, viruses, allergens, and odor molecules as well as creating clean air in the elevator which enhances passenger comfort.

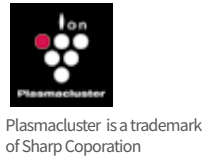
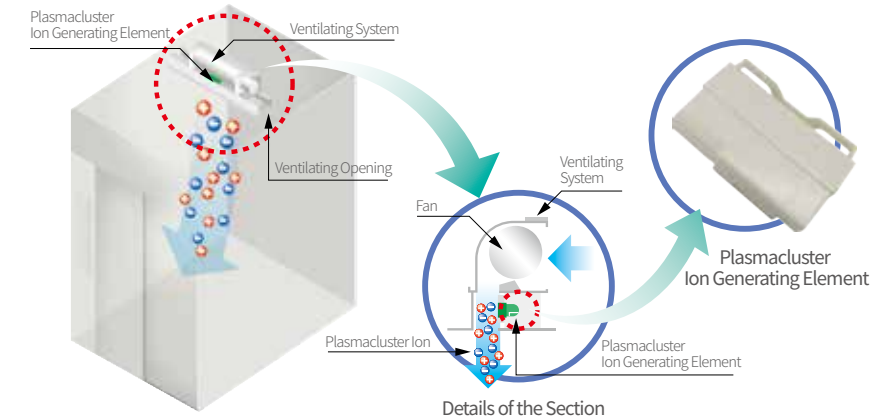

Multi-Beam Sensor

Multi-beam Sensor emits multiple infrared beams, creating an invisible curtain covering the doorway. If any of the beams is interrupted, the closing doors will stop and reopen. This function results in a significantly higher detection rate of a passenger and/or an object in the doorway.



LED Down Lights on Car Ceiling

For car ceiling lighting, Fujitec adopts LED downlights, which are long-lasting and energy-efficient. This adoption contributes to the protection of the environment.

	approx. 1,500 hours	approx. 20,000 hours	approx. 13 times
Lifetime			
Wattage	90W	9W	1/10(one-tenth)



VONIC (Automatic Voice Announcement System)

(Optional Specification)

A computerized voice system (English) provides passengers with timely information about car directions, car arrivals, door opening and closing, and emergencies, etc.

[At the customer's request, announcements in other languages can be added.]





Ceiling:
CE-g1
Paint Finished Steel Sheet (TE-a7)

Walls,Transom &Door:
Paint Finished Steel Sheet (TE-a7)

Fan:
Cross-Flow Fan

Car Operating Board:
(FX-h1) Stainless Steel with Hairline

Floor: BD-b2

Sill: Aluminum Alloy

Car Floor (Option)
(PVC Tiles)



BD-b1



BD-b2



BD-b3



BD-b4



BD-b5



BD-b6



BD-b7



BD-b8



Ceiling: Stainless Steel with Hairline Finish (Frame)
(CE-e4) Stainless Steel with Mirror Finish (Central)

Walls,Transom &Door: Stainless Steel with Hairline Finish

Fan: Cross-Flow Fan

COB: FX-k11

Floor: Designed PVC (BD-C1)

Sill: Aluminum Alloy



Ceiling: Paint Finished Steel Sheet (TE-f1)
(CE-e2)

Walls,Transom &Door: Stainless Steel with Hairline Finish

Mirror: Stainless Steel with Mirror Finish

Fan: Cross-Flow Fan

Handrail: HR-a1

WCOB: FX-g31

Floor: Designed PVC (BD-C1)

Sill: Aluminum Alloy

Optional Car Design



Ceiling: (CE-c1)	Paint Finished Steel Sheet (TE-f1)
Walls,Transom &Door:	Stainless Steel with Hairline Finish
Fan:	Cross-Flow Fan
Floor:	BD-b5
Sill:	Aluminum Alloy



Ceiling: (CE-e4)	Stainless Steel with Hairline Finish (Frame) Stainless Steel with Mirror Finish (Central)
Walls(CR-f2):	
Side Panel:	Steel Panel with Wooden Decorative Plate(Sides) Stainless Steel with Mirror Finish(Centra)
Rear Panel:	Steel Panel with Wooden Decorative Plate(Sides) Patterned Glass + Light Strip (Centra)
Front Panel, Transom :	Stainless Steel with Hairline Finish
Fan:	Cross-Flow Fan
Floor:	Designed PVC (BD-C1)
Sill:	Aluminum Alloy



Steel Panel with Wooden Decorative Plate



Ceiling: (CE-g5)	Stainless Steel with Mirror Finish
Walls(CR-f1):	
Side & Rear Panels:	Steel Plate with Laminated Sheet(TE-g1)
Wall's Centra Panels:	Stainless Steel with Mirror Finish
Front Panel,Transom:	Stainless Steel with Sandblast Finish
Door:	Stainless Steel with Sandblast Finish
Fan:	Cross-Flow Fan
Floor:	Designed PVC (BD-b8)
Sill:	Aluminum Alloy
Kick Plate:	Stainless Steel with Hairline Finish



Ceiling: (CE-e2)	Stainless Steel with Mirror Finish
Walls(CR-f1):	
Side & Rear Panels:	Steel Plate with Laminated Sheet(TE-g2)
Wall's Centra Panels:	Stainless Steel with Mirror Finish
Front Panel,Transom:	Stainless Steel with Sandblast Finish
Door:	Stainless Steel with Sandblast Finish
Fan:	Cross-Flow Fan
Floor:	Designed PVC (BD-b6)
Sill:	Aluminum Alloy
Kick Plate:	Stainless Steel with Hairline Finish

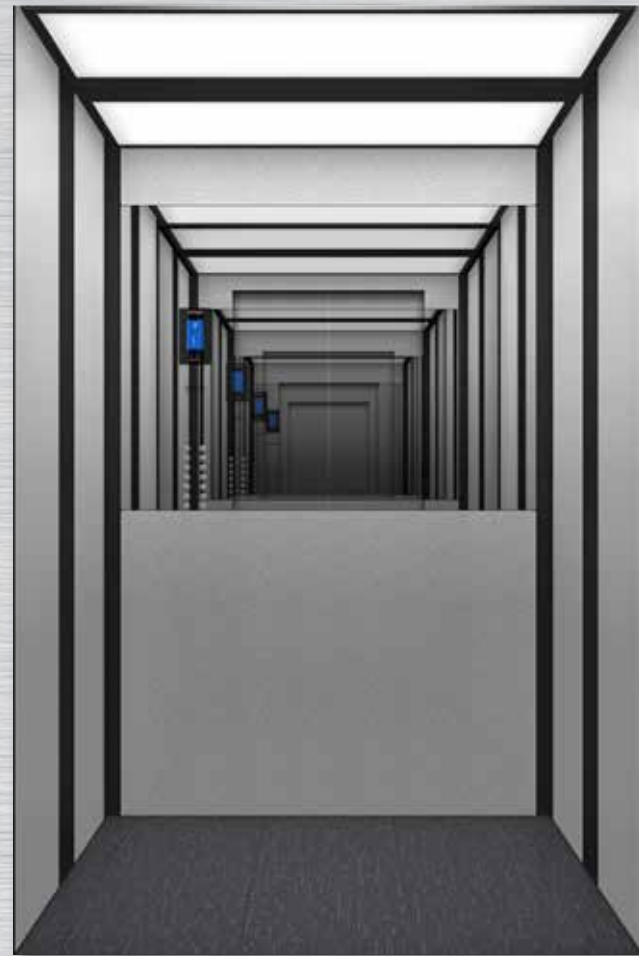

Ceiling: (CE-c5)	Paint Finished Steel Sheet (Dark Gray with Sand Texture)
Walls(CR-f3):	
Side Panels:	Light Gray Satin Coated Steel Plate Black Satin Coated Steel Plate
Rear Panel:	Light Gray Satin Coated Steel Plate Black Satin Coated Steel Plate Mirror
Front Panel, Transom:	Stainless Steel with Mirror Finish
Fan:	Cross-Flow Fan
Floor:	BD-b6
Car Operating Board:	FX-k13
Sill:	Aluminum Alloy



Ceiling: (CE-e4)	Stainless Steel with Hairline Finish (Frame) Stainless Steel with Mirror Finish (Central)
Walls(CR-f4):	
Side Panels:	Steel Plate with Laminated Sheet(TE-g1)
Rear Panel:	Stainless Steel with Mirror Finish (Two sides), Stainless Steel with Mirror Etching Finish (Central)
Front Panel, Transom :	Stainless Steel with Hairline Finish
Fan:	Cross-Flow Fan
Floor:	Designed PVC (BD-e1)
Sill:	Aluminum Alloy



CE-g1

Flat Panel:
Steel Sheet with Color Paint
Light :
LED (White)
Emergency Light (1W, LED)

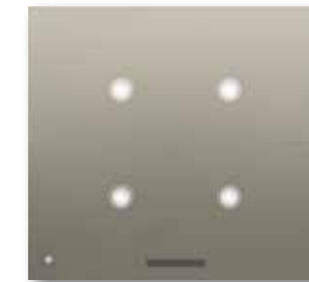

CE-g5

Flat Panel:
Steel Sheet with Color Paint
Light :
Downlight (10W, LED)
Emergency Light(1W,LED)



CE-c1

Arch-Shaped Part:
Milky-White Acrylic Sheet
Flat Part:
Steel Sheet with Color Paint
Light:
LED+ Downlight(3W, LED)
Emergency Light(5W,LED)

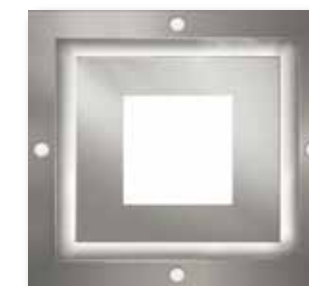

CE-e4

Frame Part:
Stainless Steel with Hairline
Central Part:
Stainless Steel with Mirror
Milky- White Acrylic Sheet
Light:
LED(White)+ Downlight(2W, LED)
Emergency Light(4.5W, LED)

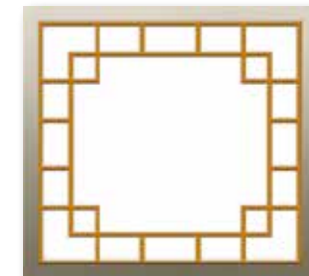

CE-c7

Flat Part:
Milky-White Acrylic Sheet
Flat Panel:
Steel Sheet with Color Paint
Light:
LED (White)
Emergency Light(5W,LED)



CE-e5

Flat Panel:
Milky-White Acrylic Sheet
Flat Panel:
Paint Finished Steel Sheet
- Dark Gray with Sand Texture
Light :
LED (White)



CE-c4

Arch-Shaped Part:
Milky-White Acrylic Sheet
Flat Part:
Steel Sheet with Color Paint
Light:
LED (White)
Emergency Light(5W,LED)

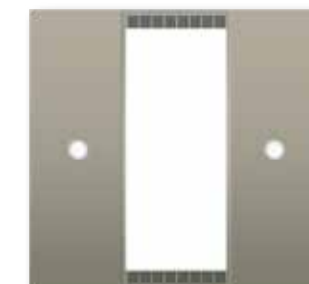

CE-e2

Arch-Shaped Part:
Milky-White Acrylic Sheet
Flat Panel:
Steel Sheet with Color Paint
Light:
LED (White)+ Downlight(3W, LED)
Emergency Light(4.5W, LED)
(In case of deep car, the design of ceiling will be changed.)

Design of CE-e2 for Deep Car:
The layout rotate by 90°.



■ Standard ■ Optional

Note: Ceiling internal height will vary based on the ceiling types.

FX-h1



Faceplate:
Stainless Steel with Hairline Finish
Indicator:
Orange Dot-Matrix LED
Buttons:
Push buttons

FX-h12



Faceplate:
Stainless Steel with Hairline Finish
Indicator:
Monochrome LCD Screen (7 inch)
Buttons:
Push buttons

FX-h11



Optional Background

Faceplate:
Stainless Steel with Hairline Finish
Indicator:
Multicolor LCD Screen (7 inch)
Buttons:
Push buttons

Wall-mounted Type

FX-h4



FX-h5



FX-h7



FX-h8



FX-h6



FX-h41



FX-h51



FX-h71



FX-h42



FX-h52



FX-h72



Faceplate:
Stainless Steel with Hairline Finish/ Acrylic Resin
Indicator:
Orange Dot-Matrix LED
Multicolor LCD Screen (4.2 inch)
Monochrome LCD (4.1 inch)
Buttons:
Push buttons

■ Standard ■ Optional

FX-k1



Faceplate: (Swing Type)
Stainless Steel with Hairline Finish
Indicator:
Orange Dot-Matrix LED
Buttons:
Push buttons

FX-k11



Faceplate: (Swing Type)
Stainless Steel with Hairline Finish
Indicator:
Multicolor LCD Screen (7 inch)
Buttons:
Push buttons

FX-k12



Faceplate: (Swing Type)
Stainless Steel with Hairline Finish
Indicator:
Multicolor LCD Screen (10.4 inch)
Buttons:
Push buttons

FX-k13



Faceplate: (Swing Type)
Stainless Steel with Hairline Finish
Indicator:
Monochrome LCD Screen (7 inch)
Buttons:
Push buttons

Note: FX-k1, FX-k11, FX-k12, FX-k13 might be not available depend on the car size.

Inserted Box Type

FX-k4



FX-k5



FX-k7



FX-k6



FX-k76



FX-k41



FX-k51

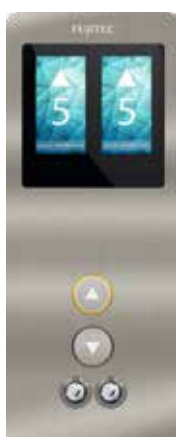

FX-k71



FX-k42



FX-k52



FX-k72

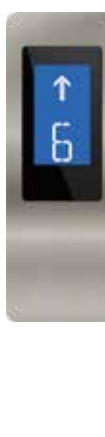

FX-k73
7 inch Multicolor LCD

■ Standard ■ Optional



Faceplate:
Stainless Steel with Hairline Finish
Indicator:
Orange Dot-Matrix LED
Multicolor LCD Screen (4.2 inch)
Monochrome LCD (4.1 inch)
Buttons:
Push buttons

FX-n41



FX-n51



FX-n71



FX-n6



FX-g32



CP-D3

Type: Stainless Steel Button with Braille Dots
When Pressed: Light Emitting Part: Ring
Lighting Color: Orange

Faceplate: Stainless Steel with Hairline Finish
Buttons: Stainless Steel Button



FX-n42



FX-n52



FX-n72



FX-n43



FX-n53



FX-n73



FX-n74



FX-n54



FX-n44

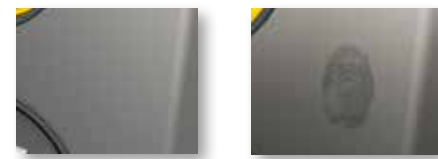

The surface of stainless steel is nano-anti-fingerprint treatment, which realizes the anti-fingerprint effect and greatly improves the anti-dirty.

Faceplate: Fingerprint Resistant Sandblasted Stainless Steel
Indicator: Multicolor LCD Screen (4.3 inch)
Monochrome LCD (5.0 inch)
Buttons: Push buttons

*It is cost-free to replace by common stainless steel with hairline finish.

Button



CP-D4

Type: Stainless Steel Button
Ring & Number emits light: Slight white light when standby, strong white light when answering.



CP-D5

Type: Stainless Steel Button with Braille Dots
Ring & Number emits light: Slight white light when standby, strong white light when answering.



RP-D1

Type: Stainless Steel Button
When Pressed: Light Emitting Part: Ring
Lighting Color: Orange



RP-D3

Type: Stainless Steel Button with Braille Dots
When Pressed: Light Emitting Part: Ring
Lighting Color: Orange



RP-E4

Type: Glass Button
Square & Number emits light: Slight white light when standby, blue light when answering.



CP-D1

Type: Stainless Steel Button
When Pressed: Light Emitting Part: Ring
Lighting Color: Orange

Handrail



HR-a1
Stainless Steel Hairline Plate



HR-b1 & b2
Stainless Steel Hairline Tube/ Stainless Steel Mirror Tube



FX-k74

Size (mm)
L440x W90 x H8
Indicator
LED
Lighting Color
White



FX-k75

Size (mm)
L440 x W100 x H14.5
Indicator
LCD (4.3 inch)
Lighting Color
Yellow



FX-k8

Size (mm)
L60 x W200 x H46
Lighting Color
Yellow



FX-k82

Size (mm)
L55 x W422 x H46.5
Lighting Color
Yellow



FX-k81

Size (mm)
L55 x W422 x H26
Lighting Color
Yellow

Note: Hall Button + Hall-Lantern combination without the Hall (Digital/LCD) Indicator is recommended when 4GSO- 8GSO* is operated by the <Immediate Announcement System of a serving Car> function is applied by FLEX- NX (200 & 300).
(* GSO = Group Supervisory Operation)



1 Car



2 Cars



Group Supervisory Control



TE-a9



TE-b1



TE-f1



TE-a7



TE-b2



TE-f2

Ceilings, Car Panels, Car Doors, Landing Doors and Jamb: Paint

Note: The colors of TE-f1 and TE-f2 are optional. *Actual colors may differ from the images.



TE-g1



TE-g2



TE-g3

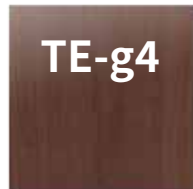

TE-g4



TE-g5

Car Side & Rear Panels: Steel Plate with Laminated Sheet

*Actual colors may differ from the images.



YS-001



YS-004



YS-007



YS-008

Car Panels, Car Doors and Landing Doors: Stainless Steel with Etching

*The dimensions of an actual pattern differ from the images.



YS-015



YS-025



YS-026



YS-059



BD-b1



BD-b2

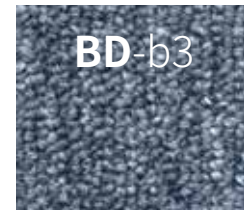

BD-b3



BD-b4

Car Floor (Vinyl Tile)

*The scale and color of an actual design differs from the images.



BD-b5



BD-b6

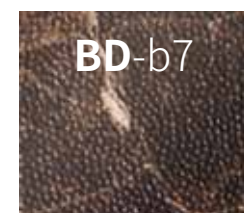

BD-b7

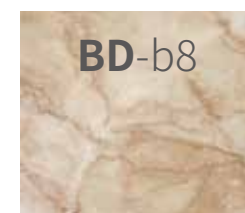

BD-b8



BD-b9



BD-b10



BD-b11



BD-e1



BD-e2



BD-c1



BD-c3

Car Floor (Designed PVC)

*The scale and color of an actual design differs from the images.

Systems & Functions

ZEXIA-D Main Specifications

Capacity* 800kg, 1050kg, 1200kg, 1350kg, 1600kg, 1800kg, 2000kg	Speed* 1.0m/s, 1.5m/s, 1.75m/s, 2.0m/s, 2.5m/s, 3.0m/s	Number of Served Floors 40 Stops or Less
Travel Height 140m	Control Method VVVF controlled by distributed 32-bit Microcomputers.	Traction Machine Gearless Machine with Permanent Magnetic Synchronous Motor
Types of Elevator Operation 1-Car or 2-Car Selective Collective Operation or Group Control Operation for 8 Cars in a Bank	Door Operation System Permanent Magnetic Gearless Motor controlled by VVVF	Door Opening Type 2-Panel Center Opening

* If the load capacity is greater than 2000kg or the speed is greater than 3m/s (but ≤ 4m/s), please contact Fujitec sales person.

* When the load is 800kg, the speed is not greater than 3m/s.

The above specifications may change without prior notice.

1. Elevator Operation Control System

Control Systems	Details of the Systems
For One Elevator: 1-Car Selective Collective Operation (Simplex)	Landing calls in the direction in which the elevator is traveling are served sequentially. After all the landing calls are served, landing calls in the opposite direction will be served. When there are no incoming calls, the elevator stops and stays at the last served floor.
For Two Elevators in a Bank: 2-Car Selective Collective Operation (Duplex)	Two selective-collective-operation elevators work together in one group. Landing calls are served by either elevator that can respond first. When there are no calls, one will be on standby at the main floor; the other will stay at the last served floor.
For Three to Eight Elevators in a Bank (Group Control Operation)	The operation of more than two elevators in a bank is controlled by a group supervisory system which calculates passenger waiting time in advance based on the accumulated traffic data, such as passenger travel patterns and passenger volume at each floor, etc.

2. Functions and Specific-Purpose Operations, etc.

Functions and Specific-Purpose Operations, etc.	Details	● : Standard / ■ : Optional		
		Standard	Optional	
Alarm Buzzer	When the emergency button is pressed, the car-top-mounted buzzer will sound an alarm.	●		
Rescue Operation to the Nearest Floor	In the event that an elevator stops between floors, a safety circuit will automatically analyze the situation and slowly move the elevator to the nearest available floor.	●		
Automatic Releveling	In the event that an elevator floor isn't leveled with the landing floor, the Automatic Releveling function will initiate and make the elevator floor flush with the landing floor.	●		
Emergency Car Lighting	In the event of a power failure, a self-charging-battery-equipped emergency lighting system will light up the elevator for passenger safety and relief.	●		
Five-Way Intercom	An intercom for 5-way communication is installed in the elevator. It allows 4 remote telephones to communicate with the elevator; one on the car top, one in the pit, one in the machine room and one in the building-system control room.	●		
Passenger-Safety Functions	Multi-Beam Sensor	A multi-beam sensor emits multiple infrared beams, which will scan at the high speed in the elevator door, forming an infrared beam barrier. If a single beam is interrupted, the sensor will stop the closing doors and reopen them.	●	
	Multi-Beam Sensor with Mechanical Safety Edge	A multiple-beam sensor can be incorporated in mechanical safety edges of elevator doors.		■
	Night-Time Self-Checking Operation	During the night time when the elevator doesn't receive any car and hall calls, the system will move the elevator and check the mechanical brake conditions automatically.	●	
	Open Door Warning	If a passenger tries to forcibly open the doors while the elevator is in operation, the warning device will sound an alarm.	●	
	Unintended Car Movement Protection (UCMP)	The Unintended Car Movement Protection system prevents elevator movement from the landing floor, while passengers are entering and getting off the elevator.	●	
	Car Door Anti Stripping Device	It can prevent passengers from falling into the hoistway when the door is opened in the non- unlocking area, and further ensure the safety of elevator passengers.	●	
	Impact Resistant Door System	The impact resistance of the landing door system is further strengthened, and the risk of falling into the hoistway caused by the impact of the landing door system is effectively prevented, further ensuring the safety of elevator related personnel.	●	

The above functions may change without prior notice.

Systems & Functions

Functions and Specific-Purpose Operations, etc.		Details	●: Standard / ■: Optional	
Efficient-Operation Functions	Anti-Nuisance Function	1) For elevators with three or more landings, when three or more car calls are registered at the same time, or when four or more car calls are registered in an extremely short period of time, the system will automatically cancel the activated car calls. 2) For elevators with five or more landings, when an elevator loaded with 100 kg or less receives four or more car call registrations, the system will cancel all the activated registrations.	●	
	Auto Adjustment of Door Open Time	This function automatically adjusts the door-hold open time (dwell time) at each floor depending on passengers' hall- and car- call registration situations.	●	
	Automatic Return to Main Floor (for 1-Car & 2-Car & Group Control Operation)	When an elevator does not receive any car- or hall- calls for a certain period of time, the Automatic Return to Main Floor function makes the elevator go to the lobby or a predetermined floor and waits in standby for passengers to board.	●	
	Door Nudging	If the car doors are held open over a given period of time, the Door Nudging function will close them slowly with an audible alarm.	●	
	Auto-Separation after Elevator Failure (for Group Control Operation)	When an elevator under group control operation fails to operate normally, it will be separated from the elevator group so as not to affect the overall group elevator performance.	●	
	Load Bypass	When a traveling car is fully loaded, it will bypass floors where hall calls are registered. Those hall calls will be assigned to another available elevator.		■
	Overload Warning	When a car becomes overloaded, the warning alarm will sound. The elevator doors will not close until the overloaded state is resolved.	●	
	Reverse-Direction Car-Call Cancellation	In the event that a passenger tries to register a car call that is behind the car's current travelling direction, the elevator system will regard it as a nuisance call and ignore it in order to maintain the elevator service efficiency.	●	
	Wrong Car-Call Register Cancellation	In case a passenger presses the wrong car call button, this mistake can be cancelled by pushing the same button twice.	●	
	Door Open Holding Button (COB)	In order to meet the demand of loading and unloading goods, a door opening extension button is installed on the operation panel in the car. Pressing this button can keep the door opening time for 3 minutes.		■
Passenger-Comfort Functions	Arrival Chime (In Car)	When a car arrives at a destination floor, an arrival chime will sound softly.		■
	Attendant Operation	By using attendant-operation buttons inside a car operating board's cabinet, authorized personnel can register car calls for in-car passengers. In addition to monitoring incoming hall calls, the attendant decides the car travel direction and operates the car doors with priority service for in-car passengers.	●	
	Automatic Voice Announcement System (VONIC)	A computerized voice system provides passengers with timely information about car directions, car arrivals, door opening and closing, and emergencies, etc. At the customer's request, announcements in other languages can be added.		■
	Plasmacluster™ Ion Generating Device (IONFUL)	Plasmacluster Ion Generating Device to be built into a car's ventilation unit creates clean air for passenger comfort by disinfecting germs, odor molecules, bacteria, viruses, and allergens in the elevator.		■
	Visual Display on Car Operating Board	Informing on an elevator's current condition, a visual display on the car operating board will provide passengers with timely text messages such as "OVERLOADED", "EMER. OPERATION", "PLEASE EXIT THE ELEVATOR." etc,	●	
	Visual Display on Landing Fixture	Informing on an elevator's current condition, a visual display on the landing fixture will provide waiting passengers with timely text messages such as "OVERLOADED", "EMER. OPERATION", etc.	●	

Functions and Specific-Purpose Operations, etc.		Details	●: Standard / ■: Optional	
Energy-Saving Functions	Automatic Fan and Light Control	If an elevator receives no car- and hall- calls within a certain period of time, its ventilation fan and lights will turn off automatically.	●	
	Elevator Operation Period Control	The elevator operation period in a day is automatically controlled by a timer mounted on the control panel's computer board in the machine room.		■
	Parking Operation	When an elevator is shifted to Parking Operation mode, the elevator will move to the pre-assigned floor and park with its doors closed, and car lights and fan turned off.		■
Specific-Purpose Operations	Battery-Powered Automatic Landing Operation (LANDIC)	In the event of a power failure, a compact battery power source will move the car to the nearest available floor.		■
	Door Opening Failure Rescue Operation	When an elevator fails to open the doors at a landing floor, it will move to the next available floor and open them.	●	
	Earthquake Rescue Operation (WAVIC)	When a seismic sensor has detected a seismic wave (the secondary seismic wave), the elevator(s) will be shifted to rescue operation mode and automatically move to the nearest available floor for passenger evacuation.		■
	Fire Operation	In the event of a fire, the Fire Operation mode will automatically take an elevator directly to a refuge floor and immobilize it there. (One refuge floor at the terminal floor)	●	
	Fireman Operation	Under automatic operation, when the Fireman's switch is on, the car will immediately cancel all the calls and run to the refuge floor. The elevator responds to the call in the car only, which is used for special fire fighting operation.		■
	Independent Operation	By turning on the Independent Operation buttons (EXCL) inside a car operating board's cabinet, the elevator only responds the car-calls, and does not respond the hall-calls.	●	
	Standby Power Operation	In the event of a power failure, the elevator(s) will return to a refuge floor using standby power and will be held there on standby. * Standby power system shall be provided and installed by third parties.		■
	Equipment for Building Security, etc.	Elevator Visual Monitoring System (ELVIC)	By monitoring the current status of running elevators and giving necessary commands to elevators through desk-top PCs in a specific remote location, ELVIC manages and controls elevator operation.	
CCTV-Camera Cables		To meet the needs of video capture or digital signal transmission such as surveillance cameras in the car, the elevator is equipped with dedicated transmission cables from the COP to the car, which can respond to various transmission schemes according to the needs of the building party.		■
Elevator Operation Supervisory Panel (such as watching board, console panel, etc.)		Through an elevator operation supervisory panel, the status of elevator operation can be monitored and controlled.		■
Building-Management-System (BMS) Interface		Through a purpose-built interface, a building management system can receive up-to-date elevator operation data.		■

The above functions may change without prior notice.

Machine Room Arrangement Of The Hoistway (Wide Car)

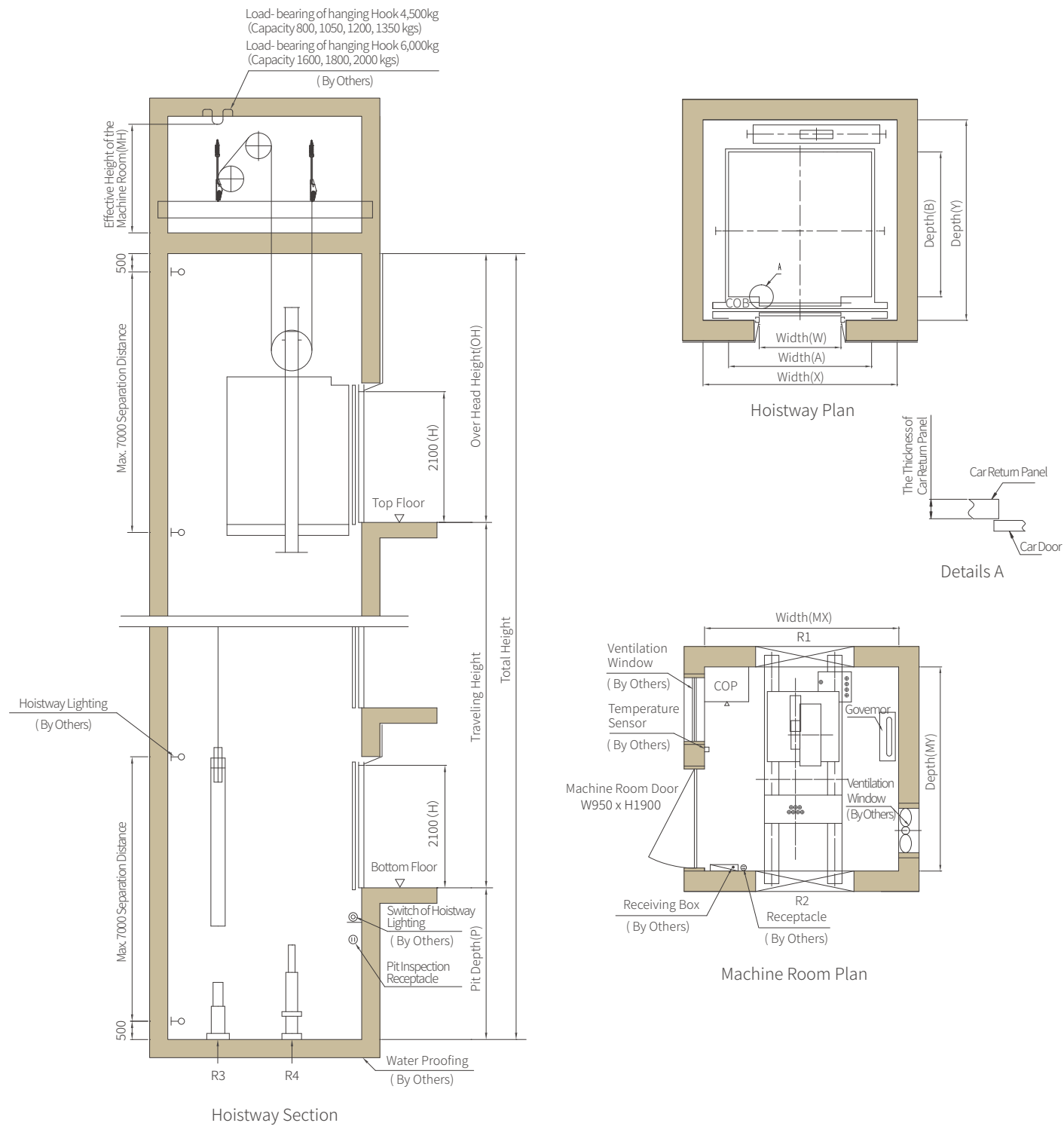

- *1. The above dimensions are for reference only. The actual engineering design data shall be used.
- *2. The above dimensions are based on RC-structure hoistway.
- *3. The location of the machine-room door in the above drawing is for reference only.
- *4. The location of the machine-room control panel in the above drawing is for reference only.
- *5. The above hoistway's internal dimensions are based on the hoistway with waterproof finish.
- *6. If hoistway's internal dimensions are too large, intermediate beams shall be provided and installed by others based on Fujitec-submitted drawings.
- *7. The required thickness of the hoistway's structural walls is 150mm or more (not including the thickness of wall finish).

Machine Room Arrangement of The Hoistway (Deep Car)

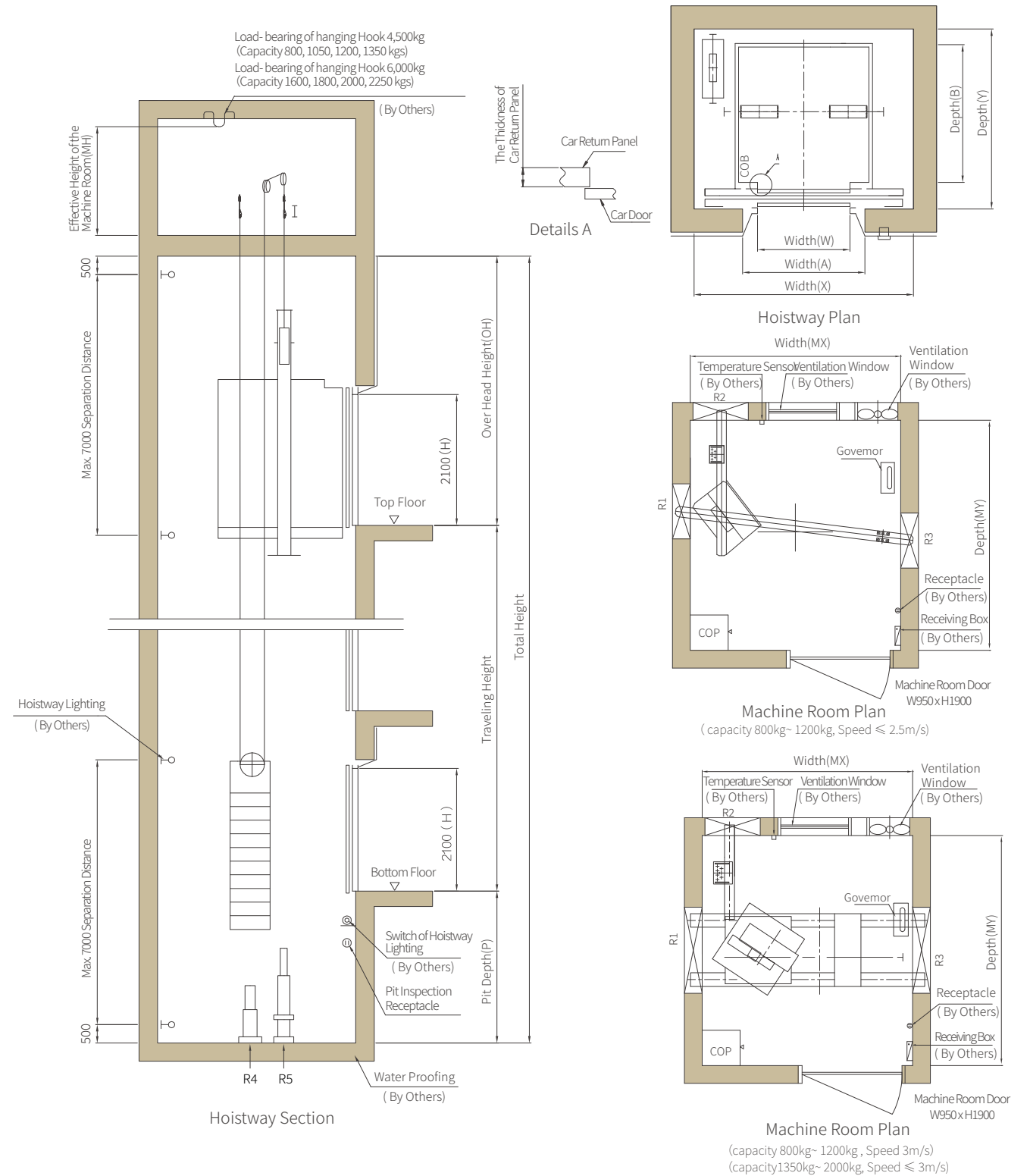

- *1. The above dimensions are for reference only. The actual engineering design data shall be used.
- *2. The above dimensions are based on RC-structure hoistway.
- *3. The location of the machine-room door in the above drawing is for reference only.
- *4. The location of the machine-room control panel in the above drawing is for reference only.
- *5. The above hoistway's internal dimensions are based on the hoistway with waterproof finish.
- *6. If hoistway's internal dimensions are too large, intermediate beams shall be provided and installed by others based on Fujitec-submitted drawings.
- *7. The required thickness of the hoistway's structural walls is 150mm or more (not including the thickness of wall finish).

800-2000Kg 2-Panel Center Opening(2CO)

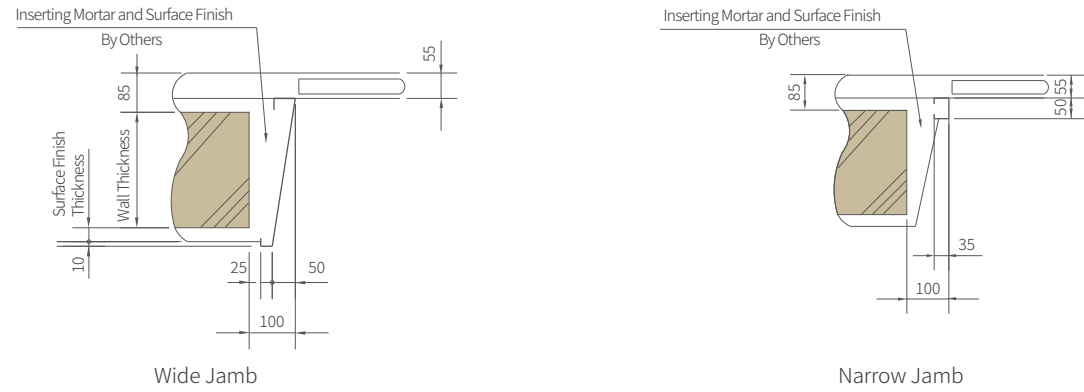

Standard Specification (Wall-Mounted Type)

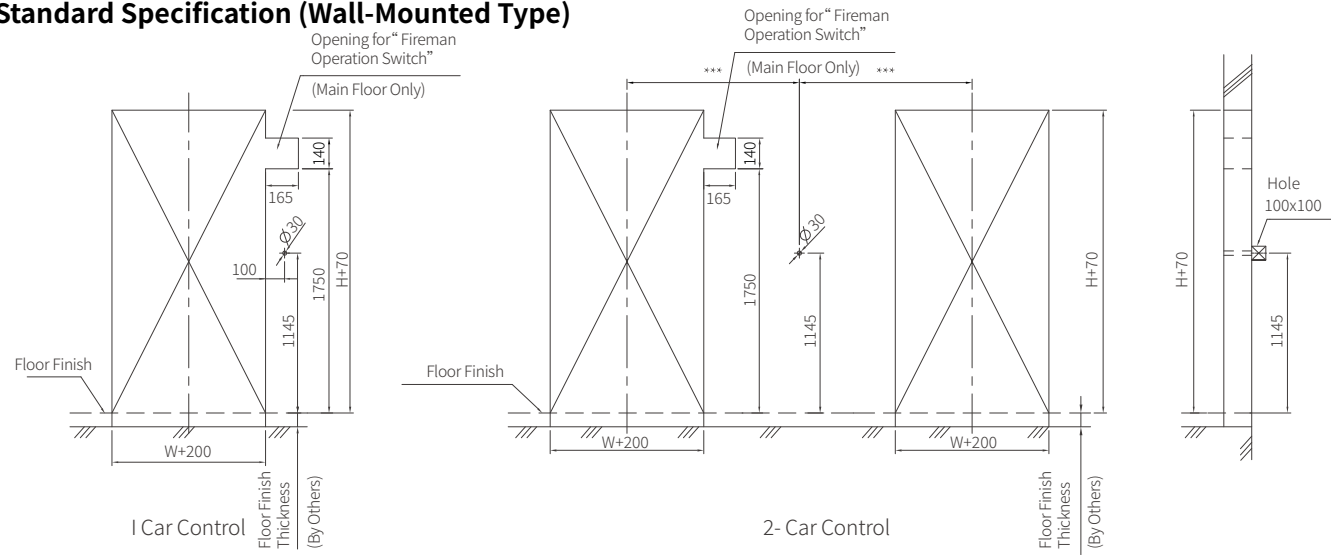

Optional Specification (Inserted Box Type)

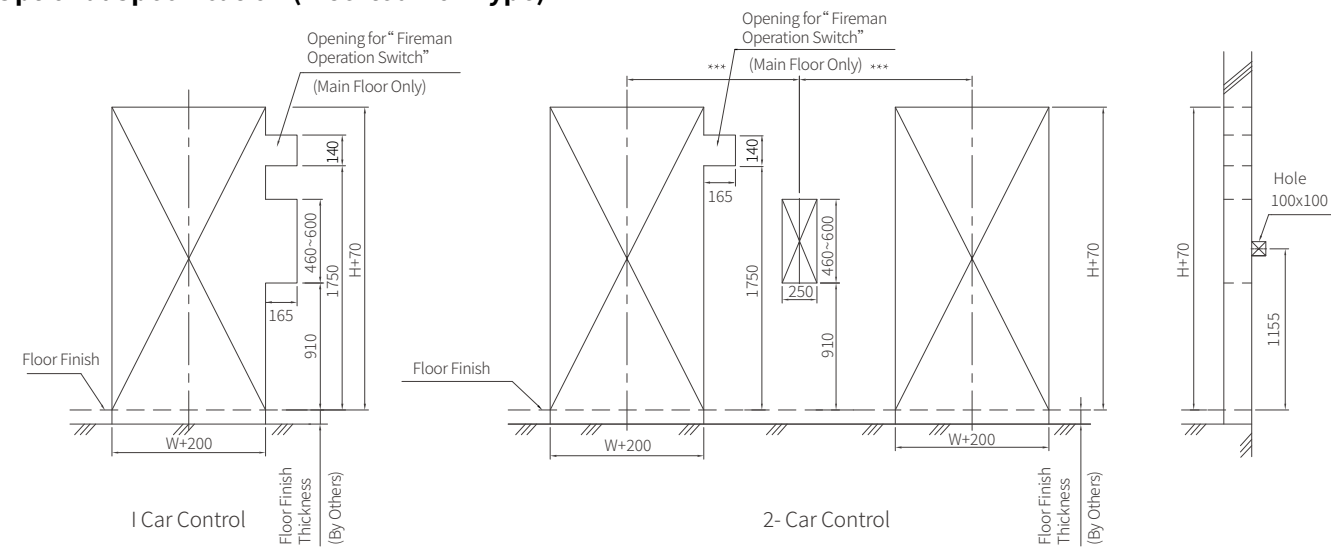

Note: The above dimensions are for reference only. The actual engineering design data shall be used.
The wide jamb for fire rated door is different from above, which should be confirmed job by job.

Capacity (kg)	Speed (m/s)	Motor Power (kW)	Rated Current (A)	Acceleration Current (A)	Equivalent Current (A)	Power Capacity (kVA)	Open Circuit Current (A)	Allowable Maximum Length of Main Power Feeder Line(m)										Heat Generation Rate in Machine Room (KJ/h)	Air Ventilation Rate in Machine Room (m ³ /h)
								25mm ²	35mm ²	50mm ²	70mm ²	95mm ²	120mm ²	150mm ²	185mm ²	240mm ²	300mm ²		
800	1.0	5.2	19	29	7	7	20	344	469	615	833	1076	1511	1813	2126	2583	2719	5050	600
	1.5	7.8	27	45	9	10	32	237	324	424	575	743	1043	1251	1468	1783	1877	7550	890
	1.75	9.0	30	50	9	11	32	218	297	389	528	682	957	1148	1347	1636	1723	8800	1040
	2.0	10.4	34	60	10	13	40	191	260	341	462	597	838	1006	1180	1434	1509	10050	1190
	2.5	13.6	42	79	14	16	50	150	205	269	364	471	661	793	931	1131	1190	12600	1480
1050	1.0	6.5	25	37	10	9	25	257	350	459	622	804	1128	1354	1588	1930	2031	6600	780
	1.5	9.7	35	55	11	12	40	181	247	324	439	567	796	956	1121	1362	1434	9900	1170
	1.75	11.4	38	61	12	14	40	167	228	298	404	522	733	880	1032	1254	1320	11550	1360
	2.0	13.0	43	72	13	16	50	147	201	263	357	461	648	777	912	1108	1166	13200	1560
	2.5	17.0	60	110	18	20	63	106	145	190	258	333	468	562	659	801	843	16500	1940
1200	1.0	7.8	30	44	11	10	32	217	296	387	525	678	952	1143	1341	1629	1715	7550	890
	1.5	11.7	41	67	13	14	50	155	211	276	375	484	680	816	957	1163	1224	11350	1340
	1.75	13.7	47	78	15	16	50	134	183	240	326	421	591	709	832	1011	1064	13200	1560
	2.0	15.6	55	94	16	18	63	116	158	207	281	363	510	612	718	872	918	15100	1780
	2.5	19.5	63	112	19	22	80	100	137	180	244	315	442	530	622	756	796	18850	2220
1350	1.0	9.2	31	46	12	12	32	208	283	371	503	650	913	1095	1285	1561	1643	8500	1000
	1.5	14.7	42	64	14	18	50	153	209	274	371	479	673	808	947	1151	1212	12750	1500
	1.75	16.0	46	73	14	19	50	139	190	249	338	436	613	735	862	1048	1103	14850	1750
	2.0	18.4	51	82	15	22	63	126	172	225	305	394	554	665	780	947	997	17000	2000
	2.5	23.0	64	111	18	27	80	99	136	178	241	311	437	525	616	748	787	21200	2500
1600	1.0	10.9	36	55	14	14	40	179	244	319	433	559	785	942	1105	1343	1413	10050	1190
	1.5	17.4	49	79	16	21	50	130	178	233	316	409	574	689	808	981	1033	15100	1780
	1.75	19.0	53	89	17	23	63	119	163	213	289	373	524	629	738	897	944	17600	2070
	2.0	21.8	58	99	18	26	63	109	149	195	265	342	481	577	677	822	866	20100	2370
	2.5	27.2	75	137	22	32	80	85	115	151	205	265	373	447	525	637	671	25150	2960
1800	1.0	12.2	40	59	16	15	40	161	220	288	390	504	708	849	996	1210	1274	11350	1340
	1.5	19.5	56	92	19	23	63	114	156	204	277	358	502	603	707	859	905	17000	2000
	1.75	21.3	59	95	18	25	63	107	147	192	260	336	472	567	665	808	851	19800	2330
	2.0	24.5	66	110	19	29	80	97	132	173	235	304	427	512	601	730	769	22650	2670
	2.5	30.6	88	157	26	36	100	0	98	129	174	226	317	380	446	542	570	28300	3330
2000	1.0	13.6	44	66	18	17	50	147	200	262	355	459	645	774	908	1103	1161	12600	1480
	1.5	21.7	61	101	21	26	63	103	141	185	251	324	455	547	641	779	820	18850	2220
	1.75	23.7	66	107	20	28	80	96	132	172	234	302	424	509	597	726	764	22000	2590
	2.0	27.2	72	121	21	32	80	88	120	158	214	276	388	465	546	663	698	25150	2960
	2.5	34.0	99	178	29	39	100	-	87	115	155	201	282	339	397	483	508	31400	3700
3.0	40.2	117	217	36	46	125	-	-	97	131	170	238	286	336	408	429	37700	4440	

Notes: 1. The data shown above may vary based on elevator specification arrangement.
2. Earthing wires shall be arranged and installed based on local elevator code requirement.

Relevant Dimensions

Counterweight at the rear

Capacity (kg)	Speed (m/s)	Opening Type	Car Inside A x B (mm)	Opening W x H (mm)	Hoistway X x Y (mm)	Machine Room Size MX x MY x MH (mm)	Pit Depth P (mm)	Overhead OH (mm)	Machine Room Reaction(kN)		Pit Reaction (kN)	
									R1	R2	R3	R4
800	1.0	2CO	1400x1350	800x2100	1800x1900	1800x1900x2200	1350	CPH+1700	76	45	90	105
	1.5						1450	CPH+1800				
	1.75						1500	CPH+1900				
	2.0						1550	CPH+2000				
	2.5						1880	CPH+2200				
	3.0						2450	CPH+2500				
1050	1.0	2CO	1600x1500	900x2100	2000x2100	2000x2100x2200	1350	CPH+1700	86	53	104	125
	1.5						1450	CPH+1800				
	1.75						1500	CPH+1900				
	2.0						1550	CPH+2000				
	2.5						1880	CPH+2200				
	3.0						2450	CPH+2500				
1200	1.0	2CO	1800x1500	1100x2100	2400x2100	2400x2100x2200	1350	CPH+1700	100	61	122	145
	1.5						1450	CPH+1800				
	1.75						1500	CPH+1900				
	2.0						1550	CPH+2000				
	2.5						1880	CPH+2200				
	3.0						2450	CPH+2500				
1350	1.0	2CO	2000x1500	1100x2100	2450x2150	2450x2150x2200	1350	CPH+1700	102	67	128	154
	1.5						1450	CPH+1800				
	1.75						1500	CPH+1900				
	2.0						1550	CPH+2000				
	2.5						1880	CPH+2200				
	3.0						2450	CPH+2500				
1600	1.0	2CO	2000x1750	1100x2100	2450x2450	2450x2450x2400	1350	CPH+1700	124	80	159	190
	1.5						1450	CPH+1800				
	1.75						1500	CPH+1900				
	2.0						1550	CPH+2000				
	2.5						1880	CPH+2200				
	3.0						2450	CPH+2500				
1800	1.0	2CO	2100x1800	1100x2100	2550x2500	2550x2500x2400	1350	CPH+1700	132	85	169	92
	1.5						1450	CPH+1800				
	1.75						1500	CPH+1900				
	2.0						1550	CPH+2000				
	2.5						1880	CPH+2200				
	3.0						2450	CPH+2500				
2000	1.0	2CO	2200x1900	1200x2100	2650x2600	2650x2600x2400	1350	CPH+1700	145	86	180	110
	1.5						1450	CPH+1800				
	1.75						1500	CPH+1900				
	2.0						1550	CPH+2000				
	2.5						1880	CPH+2200				
	3.0						2450	CPH+2500				

- Notes: 1. The data shown above may vary based on elevator specification arrangement.
 2. Refer to the Work Done by Others for the Acceptable Inclination of Hoistway's Vertical Centerline.
 3. The standard thickness of car return panel is 55 mm. It can be increased to 90 mm for the beautiful appearance with free cost, the precondition is that the depth size of hoistway and machine room should be added 35mm based on above.
 4. Car Panel Height(CPH)=Clear Ceiling Height+ Suspended Ceiling Height(SCH)
 (For CE-g1, CE-g5, CE-e2 SCH= 0mm, For CE-c1, CE-c7, CE-c4 SCH= 150mm, For CE-e4, CE-e5 SCH= 100mm.)
 5. The standard car panel height is 2350mm.

Counterweight at the side

Capacity (kg)	Speed (m/s)	Opening Type	Car Inside A x B (mm)	Opening W x H (mm)	Hoistway X x Y (mm)	Machine Room Size MX x MY x MH (mm)	Pit Depth P (mm)	Overhead OH (mm)	Machine Room Reaction(kN)			Pit Reaction (kN)	
									R1	R2	R3	R4	R5
800	1.0	2CO	1100x1800	800x2100	1900x2100	1900x2100x2200	1350	CPH+1700	78	11	45	92	107
	1.5						1450	CPH+1800					
	1.75						1500	CPH+1900					
	2.0						1550	CPH+2000					
	2.5						1880	CPH+2200					
	3.0						2450	CPH+2500					
1050	1.0	2CO	1100x2100	900x2100	2000x2450	2000x2450x2200	1350	CPH+1700	88	12	49	102	123
	1.5						1450	CPH+1800					
	1.75						1500	CPH+1900					
	2.0						1550	CPH+2000					
	2.5						1880	CPH+2200					
	3.0						2450	CPH+2500					
1200	1.0	2CO	1300x2100	1100x2100	2400x2450	2400x2450x2200	1350	CPH+1700	101	14	57	120	143
	1.5						1450	CPH+1800					
	1.75						1500	CPH+1900					
	2.0						1550	CPH+2000					
	2.5						1880	CPH+2200					
	3.0						2450	CPH+2500					
1350	1.0	2CO	1300x2300	1100x2100	2400x2650	2400x2650x2200	1350	CPH+1700	106	14	60	124	151
	1.5						1450	CPH+1800					
	1.75						1500	CPH+1900					
	2.0						1550	CPH+2000					
	2.5						1880	CPH+2200					
	3.0						2450	CPH+2500					
1600	1.0	2CO	1400x2400	1100x2100	2450x2800	2450x2800x2400	1350	CPH+1700	135	21	72	162	193
	1.5						1450	CPH+1800					
	1.75						1500	CPH+1900					
	2.0						1550	CPH+2000					
	2.5						1880	CPH+2200					
	3.0						2450	CPH+2500					
1800	1.0	2CO	1500x2400	1200x2100	2600x2800	2600x2800x2400	1350	CPH+1700	143	22	77	173	94
	1.5						1450	CPH+1800					
	1.75						1500	CPH+1900					
	2.0						1550	CPH+2000					
	2.5						1880	CPH+2200					
	3.0						2450	CPH+2500					
2000	1.0	2CO	1500x2700	1200x2100	2600x3050	2600x3050x2400	1350	CPH+1700	149	22	81	180	110
	1.5						1450	CPH+1800					
	1.75						1500	CPH+1900					
	2.0						1550	CPH+2000					
	2.5						1880	CPH+2200					
	3.0						2450	CPH+2500					

- Notes: 1. The data shown above may vary based on elevator specification arrangement.
 2. Refer to the Work Done by Others for the Acceptable Inclination of Hoistway's Vertical Centerline.
 3. The standard thickness of car return panel is 55 mm. It can be increased to 90 mm for the beautiful appearance with free cost, the precondition is that the depth size of hoistway and machine room should be added 35mm based on above.
 4. Car Panel Height(CPH)=Clear Ceiling Height+ Suspended Ceiling Height(SCH)
 (For CE-g1, CE-g5, CE-e2 SCH= 0mm, For CE-c1, CE-c7, CE-c4 SCH= 150mm, For CE-e4, CE-e5 SCH= 100mm.)
 5. The standard car panel height is 2350mm.

Work Done by Others

1. Elevator Machine-Room and Hoistway Environment

Temperature of Machine Room and Hoistway	Temperature of machine room and hoistway shall be kept from 5 °C (41 °F) to 40 °C (104 °F).
Relative Humidity	1. When a temperature reaches at 40 °C (104 °F), the relative humidity does not go beyond 50%.
	2. In the year's most humid month(s), relative humidity shall be kept lower than 90 % and the temperature lower than 25°C (77 °F).
	3. Dew condensation prevention measures shall be taken, if there are the possibilities that condensation form inside and on electrical equipment.

2. Electric Power Source

Type of Power Supply	1. Three-Phase Power Supply for Elevator Driving Machine 2. Single-Phase Power Supply for Lighting Equipment
Allowable Error of Voltage Value	The allowable error of voltage value is 7 % above and below the rated voltage.

3. Acceptable Inclination of Hoistway's Vertical Centerline

Hoistway's Vertical Length	Centerline's Tilt away from the Plumb Line (unit: mm)
30 meter or less	0 to 25 mm or less
More than 30 meters to 60 meters or less	0 to 35 mm or less
more than 60 m	0 to 50 mm or less

4. Work done by Others

The following items are in the scope of other contractors' work, not covering all items done by them.

For Hoistway

1.	Construct solid-state, fire-proof elevator hoistway.
2.	Cut out landing walls for Fujitec's installation of elevator operating fixtures and elevator equipment.
3.	Do wall finishing work by filling cement between jambs and landing walls.
4.	Do wall finishing work by filling cement between landing fixtures and landing walls.
5.	Give water-proofing and drainage treatment in elevator pit including the installation of pumping equipment.
6.	Install space divider screens between respective elevators in a hoistway pit.
7.	Install steel separator beams at regular vertical intervals in a hoistway.
8.	When hoistway is constructed with bricks, put steel lintels in their walls for Fujitec's installation of rail brackets. The steel lintels must be completely fixed inside the walls. The vertical height of the lintel is required to be 300 mm or more. For details, see the relevant drawings.
9.	When an elevator traveling distance from a floor to the next is more than 11 m, make an opening on the hoistway wall between the floors and install emergency exit doors in the opening for passenger evacuation.
10.	It is advised that there is no human access to the space below the hoistway pit.
11.	When the bottom of a hoistway pit is deeper than the required level, add backfill concrete up to the required level.
12.	Provide and install a pit ladder based on the layout drawings.
13.	Provide and install all of electricity supply apparatuses (inclusive of pipes, leads, wires, etc.) from the building's electricity supply system to the hoistway, landing floors and Fujitec-designated locations.
14.	Provide and install electrical outlets in the hoistway.
15.	Install lighting equipment of 30 watt or more at 7-meter intervals inside the hoistway with 0.5-meter clearance at the top and bottom of the hoistway. The lighting intensity is required to be 50 lux or more at the car-top working platform and at the 1-meter high position above the pit bottom.

For Machine Room

1.	Construct solid-state, fire-proof machine room.
2.	Provide and install a power switching / distributing board in the machine room.
3.	Install and lay electrical pipes, wires, and leads in the machine room. They shall be extended from the power switching / distributing board to the controller, machine, and other electrical equipment.
4.	Provide and install all of electricity supply apparatuses (inclusive of pipes, leads, wires, etc.) on various routes from the building's electricity supply system to the machine room and Fujitec-designated locations.
5.	Install lighting equipment in the machine room. The lighting intensity on the machine room's floor is 200 lux or more.
6.	Install air ventilator(s) and/or air conditioner(s) in order to keep the temperature of the machine room between 5 °C (41 °F) and 40 °C (104 °F).
7.	Provide and install electrical outlets in the machine room.
8.	Install fire-proof entrance doors in the machine room.
9.	Take a noise reduction measure, if it is required.
10.	Install smoke detector, if it is required.
11.	Make cutouts and holes in the machine room.
12.	Construct machine room floor of which 1-square-meter area can bear the load of 700 kgs.
13.	Make holes in the walls of a machine room for Fujitec's installation of machine support beams and fill concrete into the gap between the walls and the fixed beams.
14.	After the installation of electrical pipes, wires, and leads, etc. on the machine room floor, lay lightweight concrete and finish the floor surface with dust-resistant material.
15.	Make an appropriate size of opening on the roof or the sidewall of a machine room in order for Fujitec to carry in elevator machine and other equipment.
16.	Install machine lifting hooks and / or steel beams on the ceiling slabs of a machine room. The required lifting load capability is stated on the relevant installation drawings.
17.	Install windows and louvers in order to let in daylight into the machine room.
18.	If a person's entry into the machine room needs a ladder or stairs, the installation and fixation of it or them is required.
19.	In case the machine room has two or more floors and a distance between each floor is more than 500 mm, install a ladder or stairs between the floors. Guardrails shall be provided and installed on the upper floor(s) for the prevention of a person's fall.

Others

1.	Ground-fault interrupter and current leakage alarm are required to be protected against current-harmonic distortion.
2.	Lay building's telecommunication lines 500 mm away from the electric feeder lines for elevator system.
3.	Remove corroded metal materials from the machine room and the hoistway.
4.	Protect the machine room and the hoistway against hazardous gas.
5.	Prevent dust from accumulating in the hoistway and the machine room.
6.	Provide a storage room in order to stock elevator parts and installation materials.
7.	Do not place any tools and materials not related to elevators in the hoistway and the machine room.

Fujitec Global Operations



Ohio Plant (USA)



Langfang Plant (China)



Shanghai Plant (China)



Korea Plant



Taiwan Plant (China)



Big Wing (Group Headquarters in Japan, Elevator Plant)



Singapore Plant



India Plant



North & South America

- FUJITEC AMERICA, INC.
- FUJITEC CANADA, INC.
- FUJITEC VENEZUELA C.A.
- FUJITEC ARGENTINA S.A.
- FUJITEC URUGUAY S.A.

Japan

- FUJITEC CO., LTD.

East Asia

- FUJITEC (HK) CO., LTD.
- FUJITEC TAIWAN CO., LTD.
- FUJITEC KOREA CO., LTD.
- HUASHENG FUJITEC ELEVATOR CO., LTD.
- SHANGHAI HUASHENG FUJITEC ESCALATOR CO., LTD.
- FUJITEC SHANGHAI TECHNOLOGIES CO., LTD.
- FUJITEC SHANGHAI SOURCING CENTER CO., LTD.

Europe & Middle East

- FUJITEC UK LTD.
- FUJITEC SAUDI ARABIA CO., LTD.
- FUJITEC EGYPT CO., LTD.

South Asia

- FUJITEC SINGAPORE CORPN. LTD.
- FUJITEC INC. (PHILIPPINES)
- FUJITEC (MALAYSIA) SDN. BOD.
- P.T. FUJITEC INDONESIA
- FUJITEC VIETNAM CO., LTD.
- FUJITEC INDIA PRIVATE LTD.
- FUJITEC (THAILAND) CO., LTD.
- FUJITEC LANKA (PRIVATE) LTD.
- FUJITEC PACIFIC, INC. (GUAM)
- FUJITEC MYANMAR CO., LTD.

FUJITEC
www.fujitec.com

ZEXIA-D

Small-Machine-Room Elevator