



“Made in Fujitec”

Fujitec is Creating and Leading the
New Global Standard for Elevators



By manufacturing safe and reliable elevators in-house, we are building trust with people around the world.

Fujitec's "Global Common Components" are used in the REXIA-H brand. The quality of components, such as traction machines, elevator controllers, and operating fixtures, is controlled through Fujitec's integrated system of global quality management. Elevators with the same high quality will be provided by Fujitec's global supply chain under the concept of "Made in Fujitec."



Excellent Performance

The permanent magnetic synchronous gearless motors, which have been designed and developed by Fujitec, provide the utmost reliability and excellent driving performance. These motors reflect 75 years of accumulated know-how through our technological achievements in elevator manufacturing, which spans from product designing to fabrication.



Reliable Operation

Since all control-related components, ranging from control circuits to inverters, were independently developed by Fujitec, highly reliable elevator operation is established. In the event of an elevator malfunction, the elevator control system assembled with our components immediately detects the malfunction and maintains efficient and stable operation.

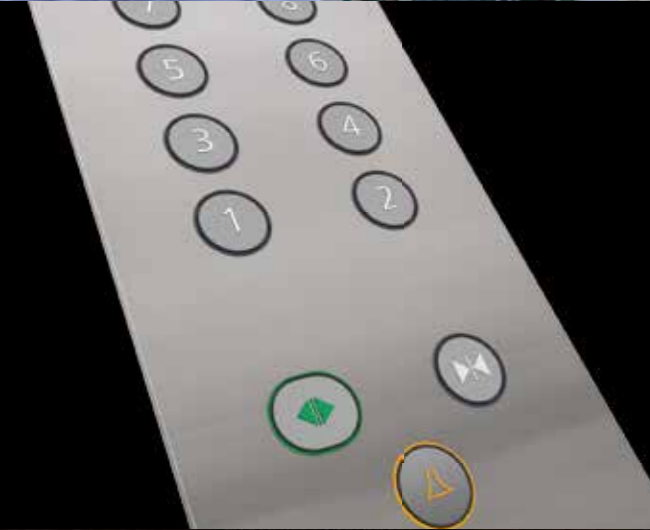

Universal Design

Under our universal designs, aesthetically refined buttons, displays, etc. on elevator operating fixtures are highly visible. Passengers will have a superb and comfortable riding experience.



Styles

Various decoration styles for the elevator interior and landing floors are offered by Fujitec. Customers can select the most suitable decorative materials for car panels, car ceilings, car floorings, car operating boards and landing fixtures.



CONTENTS

Excellent Performance	05
Reliable Operation.....	06
Universal Design.....	07
Styles.....	09
Systems & Functions.....	27
Planning.....	31
Related Data.....	34
Work Done by Others	35



Excellent Performance

Gearless Traction Machine with Permanent Magnetic Synchronous Motor

The gearless traction machine with a permanent magnet synchronous motor assure high riding comfort quality and low power consumption. This newly adopted technology reduces the weight and size of a traction machine, because gears are no longer required for elevator speed control.



No Elevator Machine Room Results in Space Saving

Our REXIA-H elevator requires no machine room space. This remarkable feature results in a reduction of building construction cost and allows building architects to maximize floor design without needing to factor in machine rooms of conventional elevator.

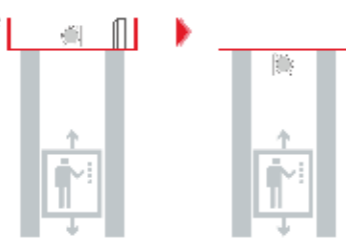

Ultra-Slim Door Operator with Permanent Magnetic Synchronous Motor

Fujitec's new door operators have adopted a permanent magnetic synchronous motor which doesn't have any gears for door speed control. The use of this kind of motor reduces the size of a door operator and achieves smooth and precise door operation.



These new door operators consume approximately

35% less power than the conventional ones.

Distributed Control System

COP: Control Panel
COB: Car Operating Board
MIC: Microcomputer
IN: Hall Indicator

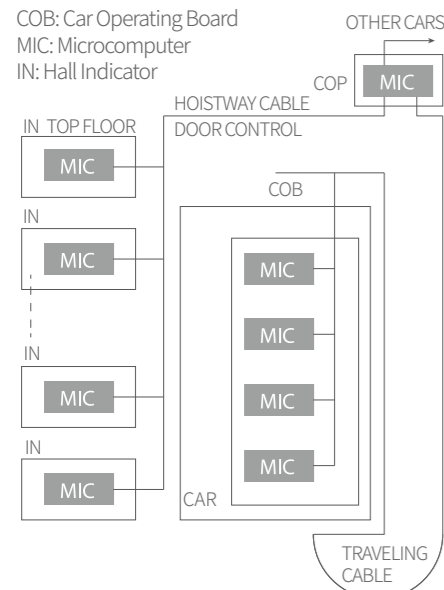

- A 32-bit data bus provides high-speed and high-precision data transmission of input-output command signals between each microprocessor located in control panels, hall-call / car-call buttons, hall indicators and hall lanterns.

- High-speed data transmits with multiple protocols enables large-scale data processing at ten times the normal speed. This also improves the ability to monitor elevator running speed, landing precision and operating reliability as well as input-output command signals of car operating fixtures and operation indicators.

- The bus system is employed for data transmission between microcomputers located in every hall-call fixture, car operating board, and control panel. This bus system has strong protection against signal interference and has system-extending capability.



An elevator operation system with multiple microcomputers makes maximum use of the "Distributed Control System." Hall indicators, car operating boards, and control panels incorporate high-performance microcomputers. These independent microcomputers analyze elevator operating conditions utilizing self-diagnostic functions and implement immediate control of elevator operations. Also, data transmission buses among microcomputers increase data processing capability.

Reliable Operation



Car Door Anti Stripping Device

It can prevent passengers from falling into the hoistway when the door is opened in the non-unlocking area, and further ensure the safety of elevator passengers.



Impact Resistant Door System

The impact resistance of the landing door system is further strengthened, and the risk of falling into the hoistway caused by the impact of the landing door system is effectively prevented, further ensuring the safety of elevator related personnel.



Unintended Car Movement Protection (UCMP)

A safety-purpose control circuit independent of the elevator operating system detects unintended movement of a car and prevents the car from moving from the floor with its doors open. This function improves passenger safety.



FLEX-NX series - Elevator Group Supervisory Control System -

Fujitec has adopted the "Virtual Passenger Optimization Method" as a new elevator group control system.

This system controls elevator group operation by virtually calculating passenger waiting time in advance based on past accumulated data, such as passenger travel patterns and passenger volume at each floor. Also, this method comprehensively calculates passenger waiting time based on extrapolated data of probable future passengers, how many passengers will come to a certain floor when a hall call is registered and/or how many passengers will come to a certain floor when no hall call is registered. This comprehensive analysis reflects whole building traffic conditions for efficient elevator operation control as well as reducing daily passenger waiting time by up to 10%.

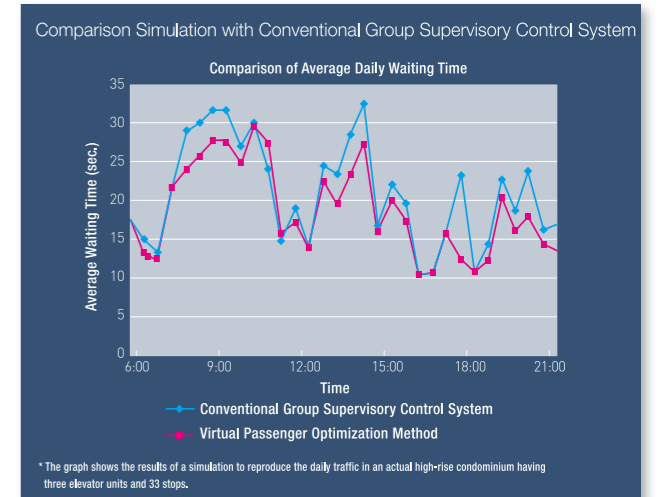



Fujitec's new global-standard operating fixtures reflect the latest in Human Engineering technology. Fixture buttons with clearly visible lettering function as the man-machine interface. Passengers can register their destination in a visually intuitive manner.

23569 23569

The newly adopted lettering for the operating fixture buttons is highly visible at wider angles than the former one. The lettering is highly visible, so that passengers anywhere under any lighting conditions in the car can see and easily read the letters and the numbers. Fujitec's uniquely designed operating fixtures function as a friendly interface between the passengers and the elevators.

The eye-catching green door open button can prevent passengers from mistaking the door open button for other buttons.

The emergency call button is located about 900mm from floor level allowing children and physically impaired to use in case of emergency.



Night-Time Self-Checking Operation

- A safety enhancement for increased reliability -

Mechanical brake conditions are automatically checked by moving the elevator during the night time while not receiving any car and hall calls.

This night-time self-checking operation increases passenger safety and contributes to a high after-sales product quality.

IONFUL

- Plasmacluster™ Ion Generating Device -

(Optional Specification)

Fujitec is the leading elevator company to have installed a Plasmacluster Ion generating device in an elevator. This device built in a car's ventilating unit disinfects airborne mold, bacteria, viruses, allergens, and odor molecules as well as creating clean air in the elevator which enhances passenger comfort.

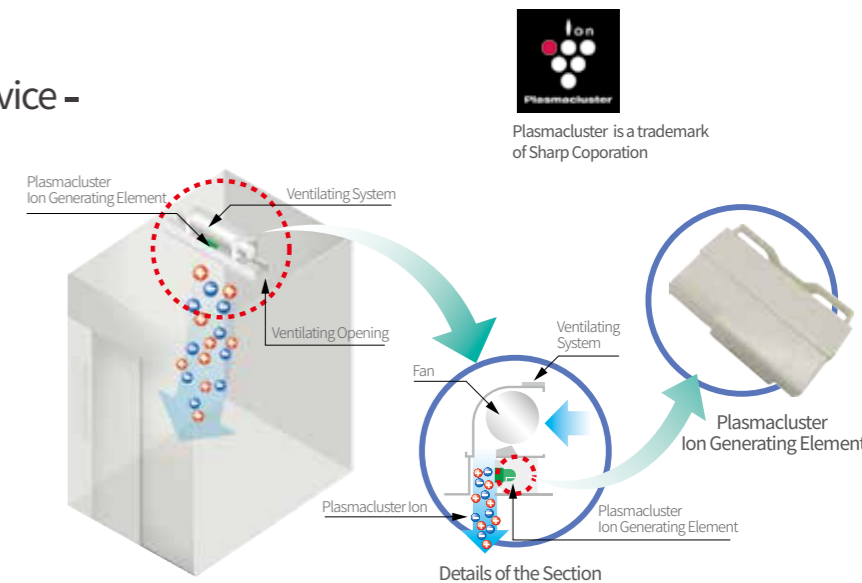

Plasmacluster is a trademark of Sharp Corporation

Multi-Beam Sensor

Multi-beam Sensor emits multiple infrared beams, creating an invisible curtain covering the doorway. If any of the beams is interrupted, the closing doors will stop and reopen. This function results in a significantly higher detection rate of a passenger and/or an object in the doorway.



LED Down Lights on Car Ceiling

For car ceiling lighting, Fujitec adopts LED downlights, which are long-lasting and energy-efficient. This adoption contributes to the protection of the environment.

	approx. 1,500 hours	approx. 20,000 hours	approx. 13 times
Lifetime			
Wattage	90W	9W	1/10(one-tenth)



VONIC (Automatic Voice Announcement System)

(Optional Specification)

A computerized voice system (English) provides passengers with timely information about car directions, car arrivals, door opening and closing, and emergencies, etc.

[At the customer's request, announcements in other languages can be added.]





Ceiling:
CE-g1
Paint Finished Steel Sheet
(TE-a7)

Walls,Transom &Door:
Paint Finished Steel Sheet
(TE-a7)

Fan:
Cross-Flow Fan

Car Operating Board:
(FX-h1) Stainless Steel with
Hairline

Floor: BD-b2

Sill: Stainless Steel

(PVC Tiles)



BD-b1



BD-b2

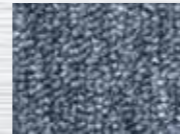

BD-b3



BD-b4



BD-b5



BD-b6



BD-b7



BD-b8



Ceiling: Stainless Steel with Hairline Finish (Frame)
(CE-e4) Stainless Steel with Mirror Finish (Central)

Walls,Transom &Door: Stainless Steel with Hairline Finish

Fan: Cross-Flow Fan

COB: FX-k11

Floor: Designed PVC (BD-C1)

Sill: Stainless Steel



Ceiling: Paint Finished Steel Sheet (TE-f1)
(CE-e2)

Walls,Transom &Door: Stainless Steel with Hairline Finish

Mirror: Stainless Steel with Mirror Finish

Fan: Cross-Flow Fan

Handrail: HR-a1

WCOB: FX-g32

Floor: Designed PVC (BD-C1)

Sill: Stainless Steel



Ceiling: (CE-c1)	Paint Finished Steel Sheet (TE-f1)
Walls,Transom &Door:	Stainless Steel with Hairline Finish
Fan:	Cross-Flow Fan
Floor:	BD-b5
Sill:	Stainless Steel



Ceiling: (CE-e4)	Stainless Steel with Hairline Finish (Frame) Stainless Steel with Mirror Finish (Central)
Walls(CR-f2):	
Side Panel:	Steel Panel with Wooden Decorative Plate(Sides) Stainless Steel with Mirror Finish(Centra)
Rear Panel:	Steel Panel with Wooden Decorative Plate(Sides) Patterned Glass + Light Strip (Centra)
Front Panel, Transom :	Stainless Steel with Hairline Finish
Fan:	Cross-Flow Fan
Floor:	Designed PVC (BD-C1)
Sill:	Stainless Steel



Steel Panel with Wooden Decorative Plate

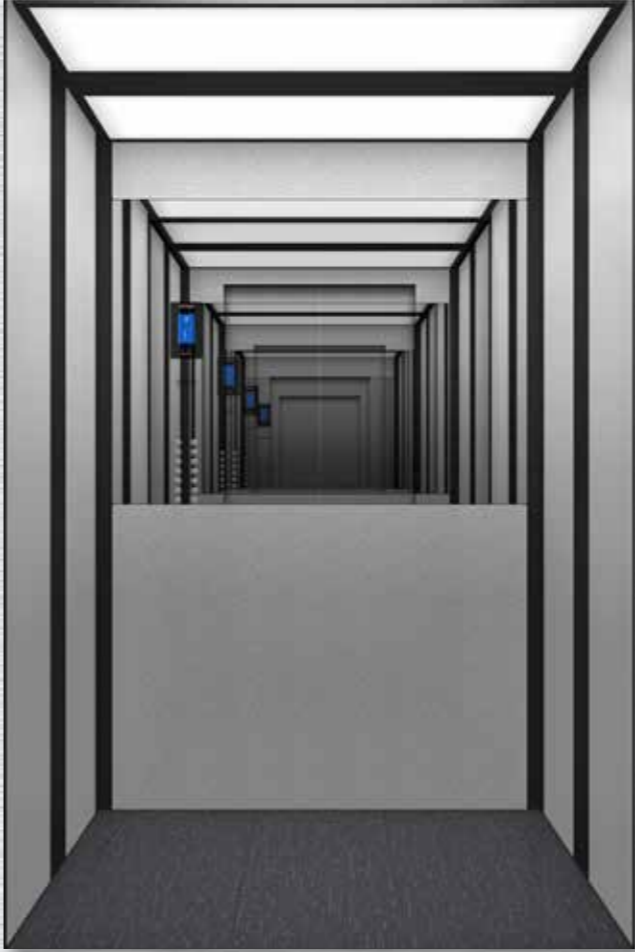

Ceiling: (CE-c5)	Paint Finished Steel Sheet (Dark Gray with Sand Texture)
Walls(CR-f3):	
Side Panels:	Light Gray Satin Coated Steel Plate Black Satin Coated Steel Plate
Rear Panel:	Light Gray Satin Coated Steel Plate Black Satin Coated Steel Plate Mirror
Front Panel, Transom:	Stainless Steel with Mirror Finish
Fan:	Cross-Flow Fan
Floor:	BD-b6
Car Operating Board:	FX-k13
Sill:	Aluminum Alloy



Ceiling: (CE-e4)	Stainless Steel with Hairline Finish (Frame) Stainless Steel with Mirror Finish (Central)
Walls(CR-f4):	
Side Panels:	Steel Plate with Laminated Sheet(TE-g1)
Rear Panel:	Stainless Steel with Mirror Finish (Two sides), Stainless Steel with Mirror Etching Finish (Central)
Front Panel, Transom :	Stainless Steel with Hairline Finish
Fan:	Cross-Flow Fan
Floor:	Designed PVC (BD-e1)
Sill:	Aluminum Alloy



Ceiling: (CE-g5)	Stainless Steel with Mirror Finish
Walls(CR-f1):	
Side & Rear Panels:	Steel Plate with Laminated Sheet(TE-g1)
Wall's Centra Panels:	Stainless Steel with Mirror Finish
Front Panel,Transom:	Stainless Steel with Sandblast Finish
Door:	Stainless Steel with Sandblast Finish
Fan:	Cross-Flow Fan
Floor:	Designed PVC (BD-b8)
Sill:	Stainless Steel
Kick Plate:	Stainless Steel with Hairline Finish



Ceiling: (CE-e2)	Stainless Steel with Mirror Finish
Walls(CR-f1):	
Side & Rear Panels:	Steel Plate with Laminated Sheet(TE-g2)
Wall's Centra Panels:	Stainless Steel with Mirror Finish
Front Panel,Transom:	Stainless Steel with Sandblast Finish
Door:	Stainless Steel with Sandblast Finish
Fan:	Cross-Flow Fan
Floor:	Designed PVC (BD-b6)
Sill:	Stainless Steel
Kick Plate:	Stainless Steel with Hairline Finish



CE-g1

Flat Panel:
Steel Sheet with Color Paint
Light :
LED (White)
Emergency Light (1W, LED)

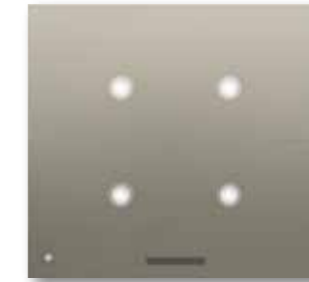

CE-g5

Flat Panel:
Steel Sheet with Color Paint
Light :
Downlight (10W, LED)
Emergency Light(1W,LED)



CE-c1

Arch-Shaped Part:
Milky-White Acrylic Sheet
Flat Part:
Steel Sheet with Color Paint
Light:
LED+ Downlight(3W, LED)
Emergency Light(5W,LED)

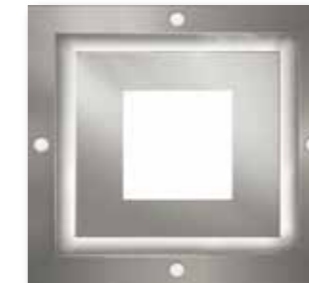

CE-e4

Frame Part:
Stainless Steel with Hairline
Central Part:
Stainless Steel with Mirror
Milky- White Acrylic Sheet
Light:
LED(White)+ Downlight(2W, LED)
Emergency Light(4.5W, LED)

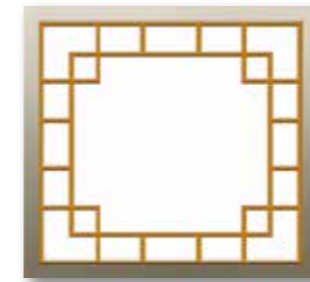

CE-c7

Flat Part:
Milky-White Acrylic Sheet
Flat Panel:
Steel Sheet with Color Paint
Light:
LED (White)
Emergency Light(5W,LED)



CE-e5

Flat Panel:
Milky-White Acrylic Sheet
Flat Panel:
Paint Finished Steel Sheet
- Dark Gray with Sand Texture
Light :
LED (White)



CE-c4

Arch-Shaped Part:
Milky-White Acrylic Sheet
Flat Part:
Steel Sheet with Color Paint
Light:
LED (White)
Emergency Light(5W,LED)

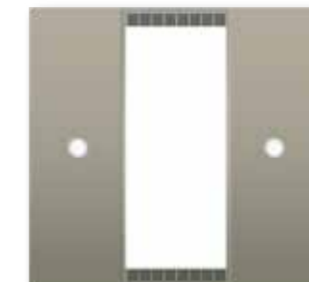

CE-e2

Arch-Shaped Part:
Milky-White Acrylic Sheet
Flat Panel:
Steel Sheet with Color Paint
Light:
LED (White)+ Downlight(3W, LED)
Emergency Light(4.5W, LED)
(In case of deep car, the design of ceiling will be changed.)

Design of CE-e2 for Deep Car:
The layout rotate by 90°.



Standard **Optional**

Note: Ceiling internal height will vary based on the ceiling types.

FX-h1



Faceplate:
Stainless Steel with Hairline Finish
Indicator:
Orange Dot-Matrix LED
Buttons:
Push buttons

FX-h12



Faceplate:
Stainless Steel with Hairline Finish
Indicator:
Monochrome LCD Screen (7 inch)
Buttons:
Push buttons

FX-h11



Optional Background

Faceplate:
Stainless Steel with Hairline Finish
Indicator:
Multicolor LCD Screen (7 inch)
Buttons:
Push buttons

Wall-mounted Type

FX-h4



FX-h5



FX-h7



FX-h8



FX-h6



FX-h41



FX-h51



FX-h71



FX-h42



FX-h52



FX-h72



Faceplate:
Stainless Steel with Hairline Finish/ Acrylic Resin
Indicator:
Orange Dot-Matrix LED
Multicolor LCD Screen (4.2 inch)
Monochrome LCD (4.1 inch)
Buttons:
Push buttons

■ Standard ■ Optional

FX-k1



Faceplate: (Swing Type)
Stainless Steel with Hairline Finish
Indicator:
Orange Dot-Matrix LED
Buttons:
Push buttons

FX-k11



Faceplate: (Swing Type)
Stainless Steel with Hairline Finish
Indicator:
Multicolor LCD Screen (7 inch)
Buttons:
Push buttons

FX-k12



Faceplate: (Swing Type)
Stainless Steel with Hairline Finish
Indicator:
Multicolor LCD Screen (10.4 inch)
Buttons:
Push buttons

FX-k13



Faceplate: (Swing Type)
Stainless Steel with Hairline Finish
Indicator:
Monochrome LCD Screen (7 inch)
Buttons:
Push buttons

Inserted Box Type

FX-k4



FX-k5



FX-k7



FX-k6



FX-k76

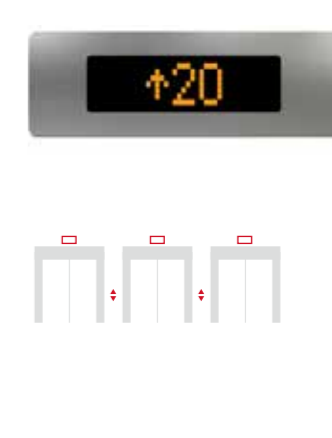

FX-k41



FX-k51



FX-k71



FX-k42



FX-k52



FX-k72



FX-k73



7 inch Multicolor LCD



Faceplate:
Stainless Steel with Hairline Finish
Indicator:
Orange Dot-Matrix LED
Multicolor LCD Screen (4.2 inch)
Monochrome LCD (4.1 inch)
Buttons:
Push buttons

Standard Optional

Note: FX-k1, FX-k11, FX-k12, FX-k13 might be not available depend on the car size.

Car Operating Boards

FX-n41



FX-n51



FX-n71



FX-n6



FX-n42



FX-n52



FX-n72



FX-n43



FX-n53



FX-n73



FX-n74



FX-n54



FX-n44



The surface of stainless steel is nano-anti-fingerprint treatment, which realizes the anti-fingerprint effect and greatly improves the anti-dirty.

- Faceplate:**
Fingerprint Resistant Sandblasted Stainless Steel
- Indicator:**
Multicolor LCD Screen (4.3 inch)
Monochrome LCD (5.0 inch)
- Buttons:**
Push buttons

*It is cost-free to replace by common stainless steel with hairline finish.



Hall Fixtures

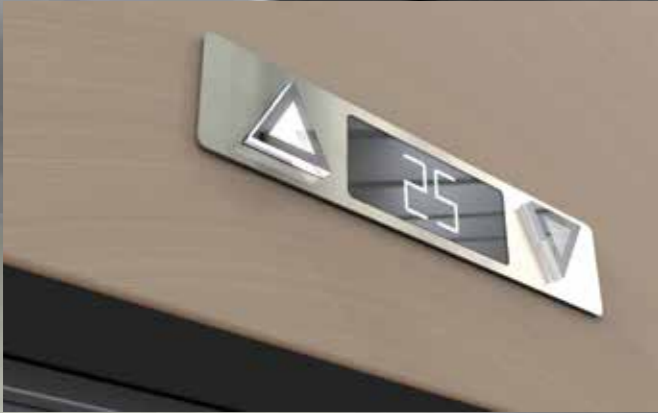

FX-k74

Size (mm)
L440x W90 x H8
Indicator
LED
Lighting Color
White



FX-k75

Size (mm)
L440 x W100 x H14.5
Indicator
LCD (4.3 inch)
Lighting Color
Yellow



FX-k8

Size (mm)
L60 x W200 x H46
Lighting Color
Yellow



FX-k81

Size (mm)
L55 x W422 x H26
Lighting Color
Yellow



FX-k82

Size (mm)
L55 x W422 x H46.5
Lighting Color
Yellow

Note: Hall Button + Hall-Lantern combination without the Hall (Digital/LCD) Indicator is recommended when 4GSO- 8GSO* is operated by the <Immediate Announcement System of a serving Car> function is applied by FLEX- NX (202 & 300).
(* GSO = Group Supervisory Operation)

FX-g32



CP-D3

Type: Stainless Steel Button with Braille Dots
 When Pressed: Light Emitting Part: Ring
 Lighting Color: Orange

Faceplate: Stainless Steel with Hairline Finish
 Buttons: Stainless Steel Button



Button



CP-D4

Type: Stainless Steel Button
 Ring & Number emits light: Slight white light when standby, strong white light when answering.



CP-D5

Type: Stainless Steel Button with Braille Dots
 Ring & Number emits light: Slight white light when standby, strong white light when answering.



RP-D1

Type: Stainless Steel Button
 When Pressed: Light Emitting Part: Ring
 Lighting Color: Orange



RP-D3

Type: Stainless Steel Button with Braille Dots
 When Pressed: Light Emitting Part: Ring
 Lighting Color: Orange



RP-E4

Type: Glass Button
 Square & Number emits light: Slight white light when standby, blue light when answering.



CP-D1

Type: Stainless Steel Button
 When Pressed: Light Emitting Part: Ring
 Lighting Color: Orange

Handrail



HR-a1

Stainless Steel Hairline Plate



HR-b1 & b2

Stainless Steel Hairline Tube/ Stainless Steel Mirror Tube



TE-a9



TE-a7



TE-b1



TE-b2

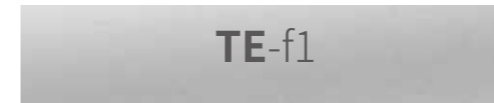

TE-f1

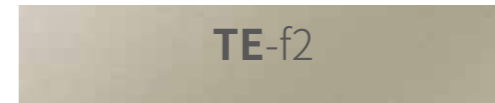

TE-f2

Ceilings, Car Panels, Car Doors, Landing Doors and Jamb: Paint

Note: The colors of TE-f1 and TE-f2 are optional. *Actual colors may differ from the images.

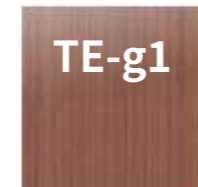

TE-g1

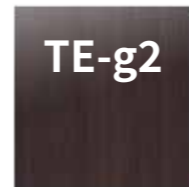

TE-g2



TE-g3



TE-g4



TE-g5

Car Side & Rear Panels: Steel Plate with Laminated Sheet

*Actual colors may differ from the images.



YS-001

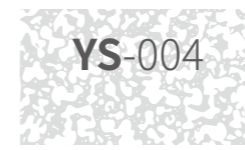

YS-004

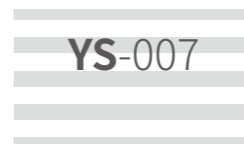

YS-007



YS-008

Car Panels, Car Doors and Landing Doors: Stainless Steel with Etching

*The dimensions of an actual pattern differ from the images.



YS-015

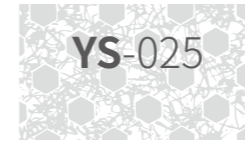

YS-025



YS-026



YS-059



BD-b1

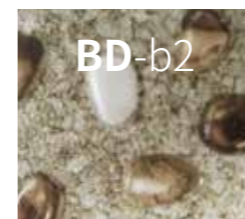

BD-b2

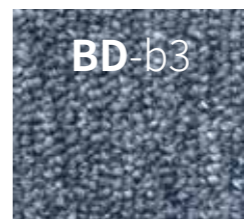

BD-b3



BD-b4

Car Floor (Vinyl Tile)

*The scale and color of an actual design differs from the images.



BD-b5



BD-b6

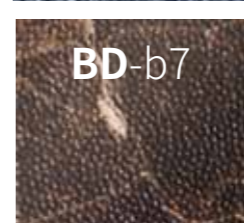

BD-b7

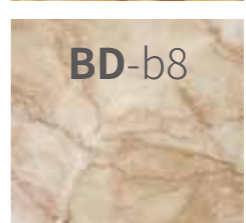

BD-b8

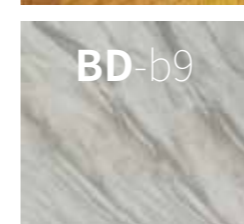

BD-b9



BD-b10



BD-b11

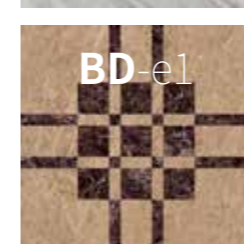

BD-e1



BD-e2

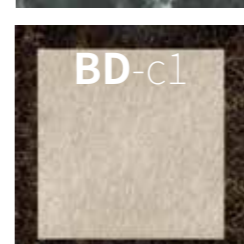

BD-c1



BD-c3

Car Floor (Designed PVC)

*The scale and color of an actual design differs from the images.

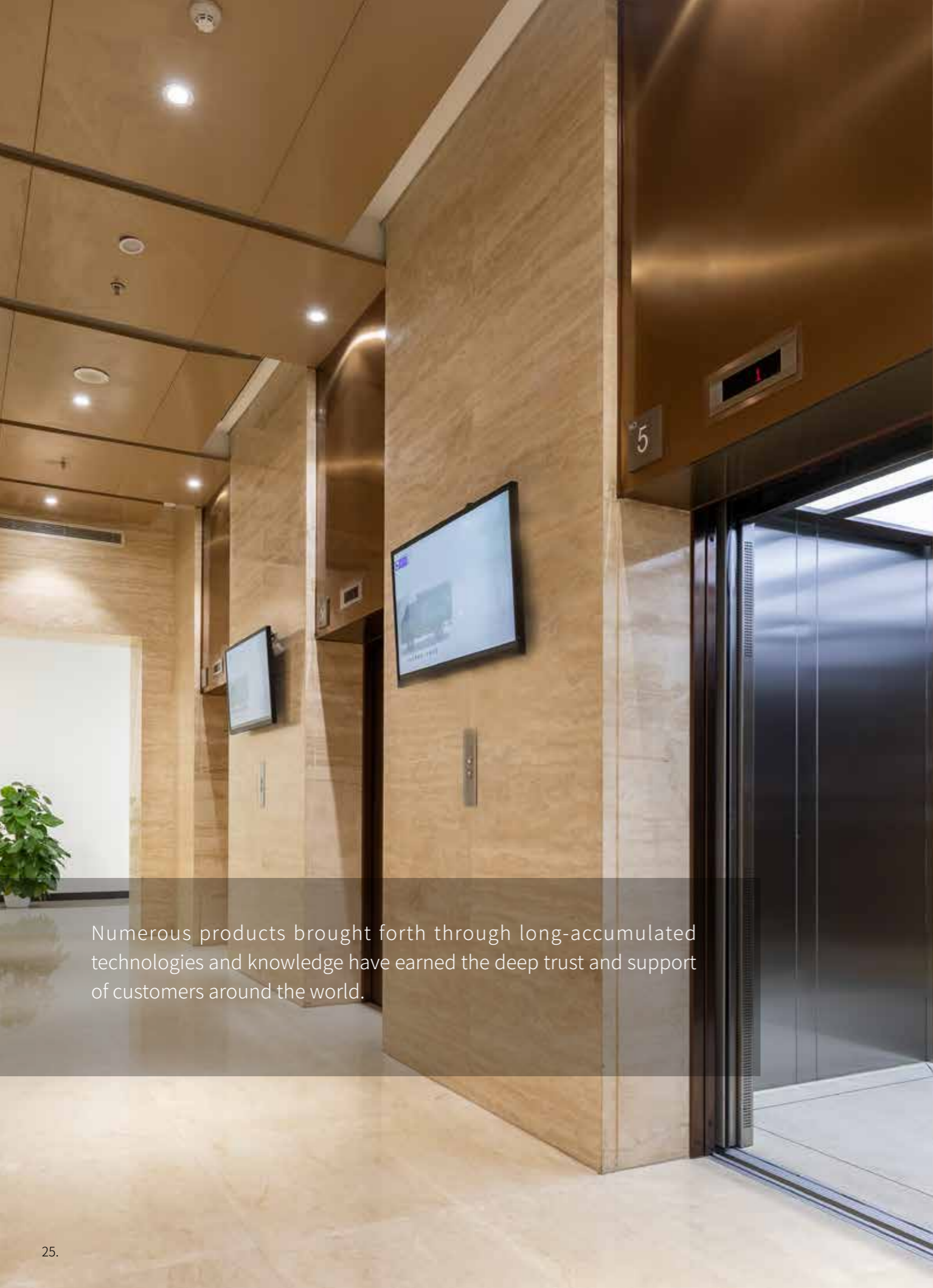

Numerous products brought forth through long-accumulated technologies and knowledge have earned the deep trust and support of customers around the world.



1 Car



2 Cars



Group Supervisory Control

Systems & Functions

REXIA-H Main Specifications

Capacity 450kg, 630kg, 800kg, 1000kg, 1050kg	Speed 1.0m/s, 1.5m/s, 1.75m/s, 2.0m/s	Number of Served Floors 30 Stops or Less
Travel Height Main Specifications 80m or less	Control Method VVVF controlled by distributed 32-bit Microcomputers.	Traction Machine Gearless Machine with Permanent Magnetic Synchronous Motor
Types of Elevator Operation 1-Car or 2-Car Selective Collective Operation or Group Control Operation for 4 Cars in a Bank	Door Operation System Permanent Magnetic Gearless Motor controlled by VVVF	Door Opening Type 2-Panel Center Opening <small>"Note: The elevator of 450kg load capacity is equipped with 2-Panel Side Opening door as standard."</small>

The above specifications may change without prior notice.

1. Elevator Operation Control System

Control Systems	Details of the Systems
For One Elevator: 1-Car Selective Collective Operation (Simplex)	Landing calls in the direction in which the elevator is traveling are served sequentially. After all the landing calls are served, landing calls in the opposite direction will be served. When there are no incoming calls, the elevator stops and stays at the last served floor.
For Two Elevators in a Bank: 2-Car Selective Collective Operation (Duplex)	Two selective-collective-operation elevators work together in one group. Landing calls are served by either elevator that can respond first. When there are no calls, one will be on standby at the main floor; the other will stay at the last served floor.
For Three to Four Elevators in a Bank (Group Control Operation)	The operation of more than two elevators in a bank is controlled by a group supervisory system which calculates passenger waiting time in advance based on the accumulated traffic data, such as passenger travel patterns and passenger volume at each floor, etc.

2. Functions and Specific-Purpose Operations, etc.

Functions and Specific-Purpose Operations, etc.	Details	● : Standard / ■ : Optional		
Alarm Buzzer	When the emergency button is pressed, the car-top-mounted buzzer will sound an alarm.	●		
Rescue Operation to the Nearest Floor	In the event that an elevator stops between floors, a safety circuit will automatically analyze the situation and slowly move the elevator to the nearest available floor.	●		
Automatic Releveling	In the event that an elevator floor isn't leveled with the landing floor, the Automatic Releveling function will initiate and make the elevator floor flush with the landing floor.	●		
Emergency Car Lighting	In the event of a power failure, a self-charging-battery-equipped emergency lighting system will light up the elevator for passenger safety and relief.	●		
Five-Way Intercom	An intercom for 5-way communication is installed in the elevator. It allows 4 remote telephones to communicate with the elevator; one on the car top, one in the pit, one in the machine room and one in the building-system control room.	●		
Passenger-Safety Functions	Multi-Beam Sensor	A multi-beam sensor emits multiple infrared beams, which will scan at the high speed in the elevator door, forming an infrared beam barrier. If a single beam is interrupted, the sensor will stop the closing doors and reopen them.	●	
	Multi-Beam Sensor with Mechanical Safety Edge	A multiple-beam sensor can be incorporated in mechanical safety edges of elevator doors.		■
	Night-Time Self-Checking Operation	During the night time when the elevator doesn't receive any car and hall calls, the system will move the elevator and check the mechanical brake conditions automatically.	●	
	Open Door Warning	If a passenger tries to forcibly open the doors while the elevator is in operation, the warning device will sound an alarm.	●	
	Unintended Car Movement Protection (UCMP)	The Unintended Car Movement Protection system prevents elevator movement from the landing floor, while passengers are entering and getting off the elevator.	●	
	Car Door Anti Stripping Device	It can prevent passengers from falling into the hoistway when the door is opened in the non- unlocking area, and further ensure the safety of elevator passengers.	●	
	Impact Resistant Door System	The impact resistance of the landing door system is further strengthened, and the risk of falling into the hoistway caused by the impact of the landing door system is effectively prevented, further ensuring the safety of elevator related personnel.	●	

The above functions may change without prior notice.

Systems & Functions

Functions and Specific-Purpose Operations, etc.		Details	●: Standard / ■: Optional	
Efficient-Operation Functions	Anti-Nuisance Function	1) For elevators with three or more landings, when three or more car calls are registered at the same time, or when four or more car calls are registered in an extremely short period of time, the system will automatically cancel the activated car calls. 2) For elevators with five or more landings, when an elevator loaded with 100 kg or less receives four or more car call registrations, the system will cancel all the activated registrations.	●	
	Auto Adjustment of Door Open Time	This function automatically adjusts the door-hold open time (dwell time) at each floor depending on passengers' hall- and car- call registration situations.	●	
	Automatic Return to Main Floor (for 1-Car & 2-Car & Group Control Operation)	When an elevator does not receive any car- or hall- calls for a certain period of time, the Automatic Return to Main Floor function makes the elevator go to the lobby or a predetermined floor and waits in standby for passengers to board.	●	
	Door Nudging	If the car doors are held open over a given period of time, the Door Nudging function will close them slowly with an audible alarm.	●	
	Auto-Separation after Elevator Failure (for Group Control Operation)	When an elevator under group control operation fails to operate normally, it will be separated from the elevator group so as not to affect the overall group elevator performance.	●	
	Load Bypass	When a traveling car is fully loaded, it will bypass floors where hall calls are registered. Those hall calls will be assigned to another available elevator.		■
	Overload Warning	When a car becomes overloaded, the warning alarm will sound. The elevator doors will not close until the overloaded state is resolved.	●	
	Reverse-Direction Car-Call Cancellation	In the event that a passenger tries to register a car call that is behind the car's current travelling direction, the elevator system will regard it as a nuisance call and ignore it in order to maintain the elevator service efficiency.	●	
	Wrong Car-Call Register Cancellation	In case a passenger presses the wrong car call button, this mistake can be cancelled by pushing the same button twice.	●	
	Door Open Holding Button (COB)	In order to meet the demand of loading and unloading goods, a door opening extension button is installed on the operation panel in the car. Pressing this button can keep the door opening time for 3 minutes.		■
Passenger-Comfort Functions	Arrival Chime (In Car)	When a car arrives at a destination floor, an arrival chime will sound softly.		■
	Attendant Operation	By using attendant-operation buttons inside a car operating board's cabinet, authorized personnel can register car calls for in-car passengers. In addition to monitoring incoming hall calls, the attendant decides the car travel direction and operates the car doors with priority service for in-car passengers.	●	
	Automatic Voice Announcement System (VONIC)	A computerized voice system provides passengers with timely information about car directions, car arrivals, door opening and closing, and emergencies, etc. At the customer's request, announcements in other languages can be added.		■
	Plasmacluster™ Ion Generating Device (IONFUL)	Plasmacluster Ion Generating Device to be built into a car's ventilation unit creates clean air for passenger comfort by disinfecting germs, odor molecules, bacteria, viruses, and allergens in the elevator.		■
	Visual Display on Car Operating Board	Informing on an elevator's current condition, a visual display on the car operating board will provide passengers with timely text messages such as "OVERLOADED", "EMER. OPERATION", "PLEASE EXIT THE ELEVATOR." etc,	●	
	Visual Display on Landing Fixture	Informing on an elevator's current condition, a visual display on the landing fixture will provide waiting passengers with timely text messages such as "OVERLOADED", "EMER. OPERATION", etc.	●	

Functions and Specific-Purpose Operations, etc.		Details	●: Standard / ■: Optional	
Energy-Saving Functions	Automatic Fan and Light Control	If an elevator receives no car- and hall- calls within a certain period of time, its ventilation fan and lights will turn off automatically.	●	
	Elevator Operation Period Control	The elevator operation period in a day is automatically controlled by a timer mounted on the control panel's computer board in the machine room.		■
	Parking Operation	When an elevator is shifted to Parking Operation mode, the elevator will move to the pre-assigned floor and park with its doors closed, and car lights and fan turned off.		■
Specific-Purpose Operations	Battery-Powered Automatic Landing Operation (LANDIC)	In the event of a power failure, a compact battery power source will move the car to the nearest available floor.		■
	Door Opening Failure Rescue Operation	When an elevator fails to open the doors at a landing floor, it will move to the next available floor and open them.	●	
	Earthquake Rescue Operation (WAVIC)	When a seismic sensor has detected a seismic wave (the secondary seismic wave), the elevator(s) will be shifted to rescue operation mode and automatically move to the nearest available floor for passenger evacuation.		■
	Fire Operation	In the event of a fire, the Fire Operation mode will automatically take an elevator directly to an refuge floor and immobilize it there. (One refuge floor at the terminal floor)	●	
	Fireman Operation	Under automatic operation, when the Fireman's switch is on, the car will immediately cancel all the calls and run to the refuge floor. The elevator responds to the call in the car only, which is used for special fire fighting operation.		■
	Independent Operation	By turning on the Independent Operation buttons (EXCL) inside a car operating board's cabinet, the elevator only responds the car-calls, and does not respond the hall-calls.	●	
	Standby Power Operation	In the event of a power failure, the elevator(s) will return to an refuge floor using standby power and will be held there on standby. * Standby power system shall be provided and installed by third parties.		■
	Elevator Visual Monitoring System (ELVIC)	By monitoring the current status of running elevators and giving necessary commands to elevators through desk-top PCs in a specific remote location, ELVIC manages and controls elevator operation.		■
Equipment for Building Security, etc.	CCTV-Camera Cables	To meet the needs of video capture or digital signal transmission such as surveillance cameras in the car, the elevator is equipped with dedicated transmission cables from the COP to the car, which can respond to various transmission schemes according to the needs of the building party.		■
	Elevator Operation Supervisory Panel (such as watching board, console panel, etc.)	Through an elevator operation supervisory panel, the status of elevator operation can be monitored and controlled.		■
	Building-Management-System (BMS) Interface	Through a purpose-built interface, a building management system can receive up-to-date elevator operation data.		■

The above functions may change without prior notice.

Planning

450Kg 2-Panel Right Side Opening Door (2SR)

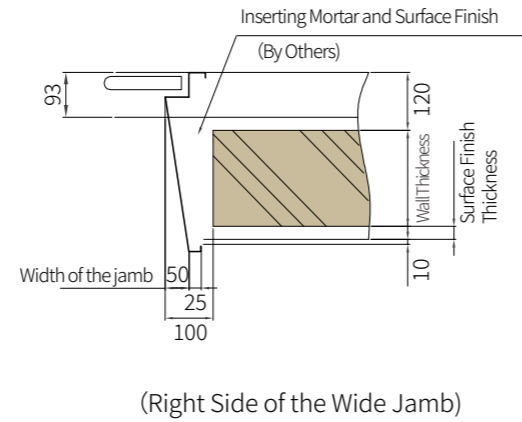
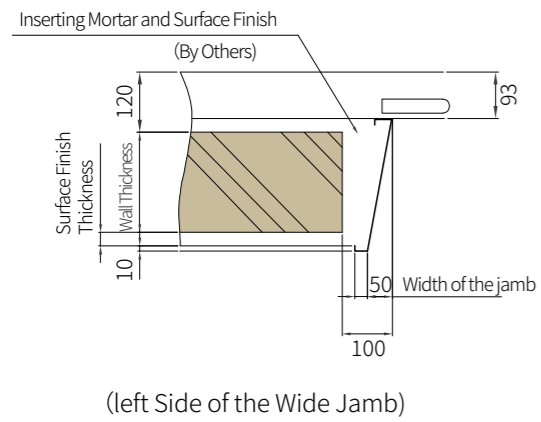
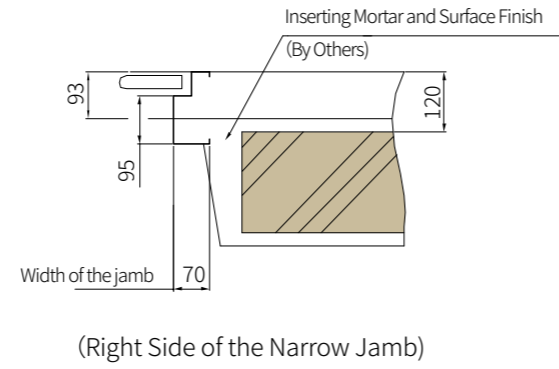
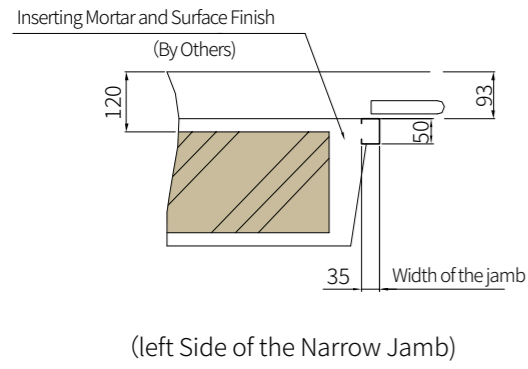

630-1050Kg 2-Panel Center Opening(2CO)

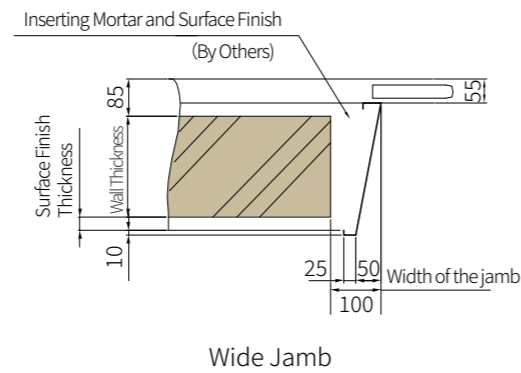
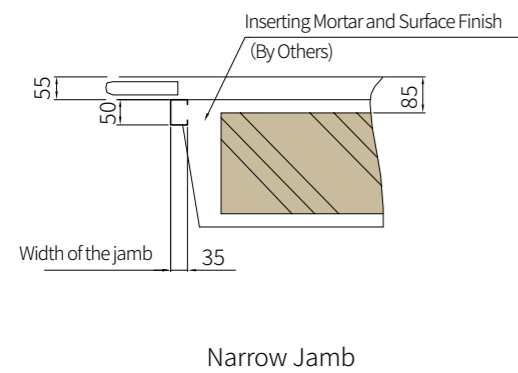

Note: The above dimensions are for reference only. The actual engineering design data shall be used.

Standard Specification (Wall-Mounted Type)

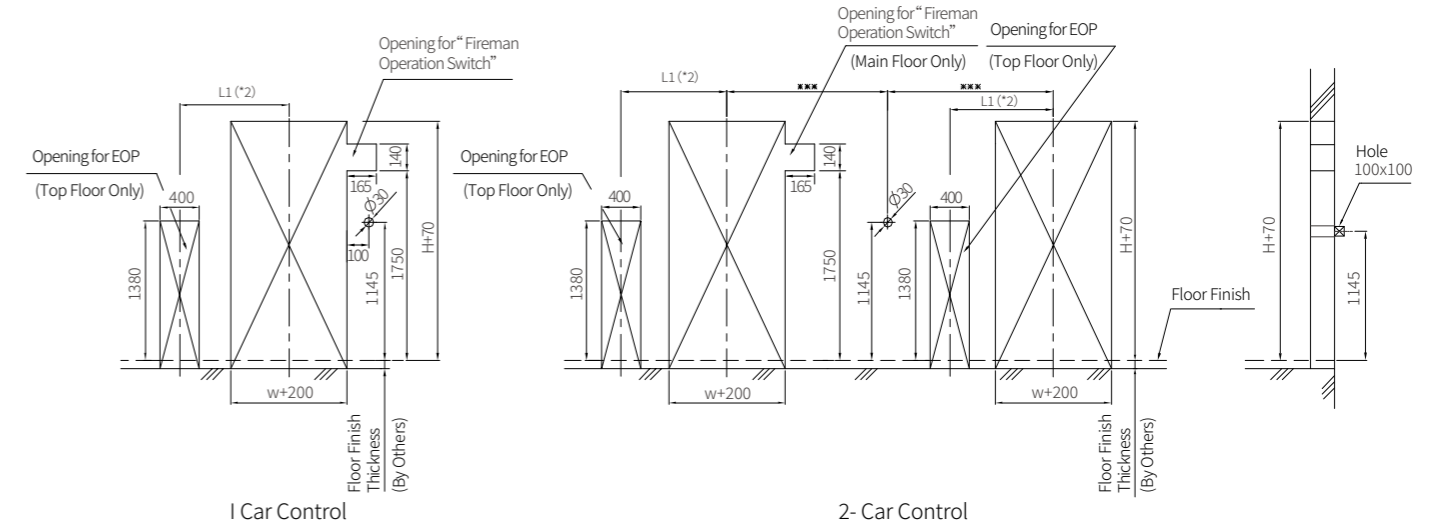

Optional Specification (Inserted Box Type)

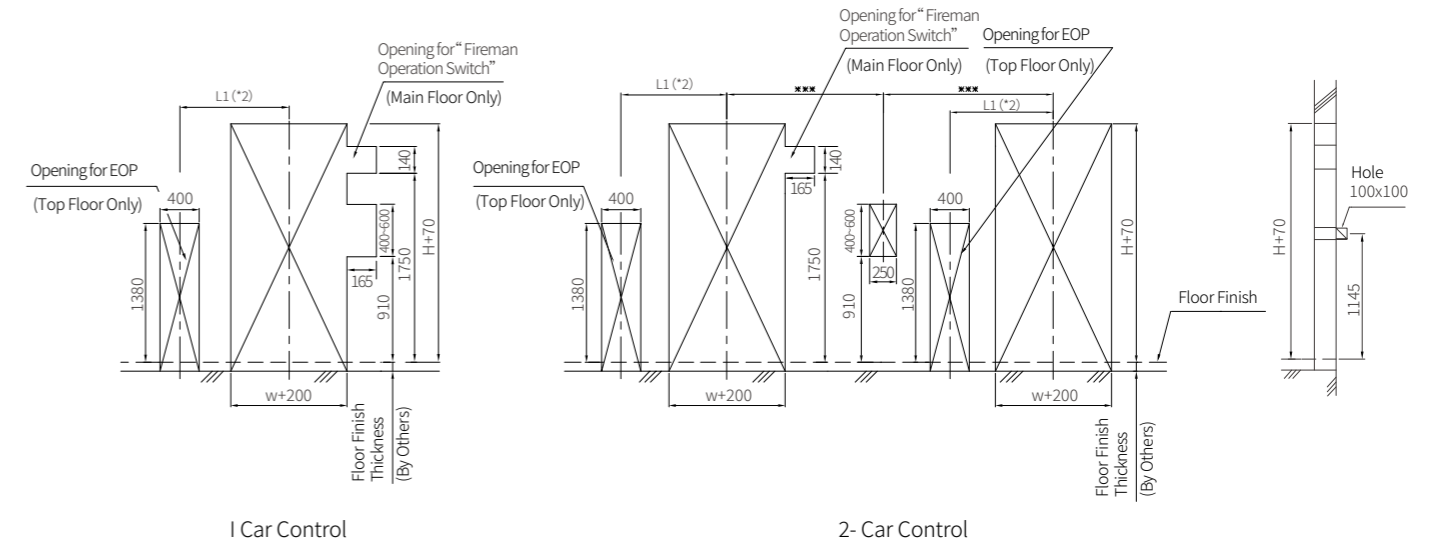

Note 1: The above dimensions are for reference only. The actual engineering design data shall be used.

Note 2:

Length (mm)	2SL	2CO
L1(mm)	IW/2+300	IW/2+205 (IW=Car Inside Width)

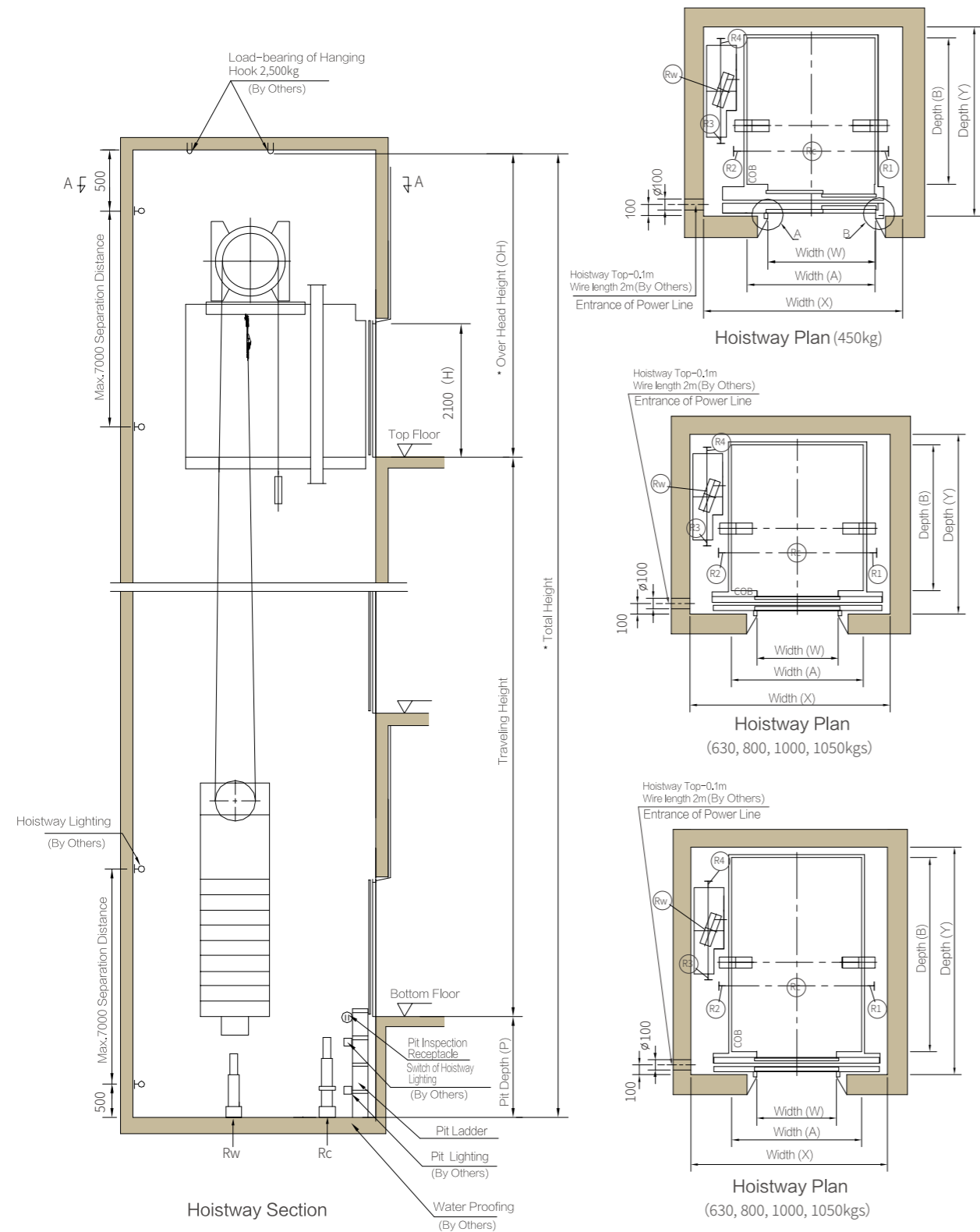

Relevant Dimensions

Capacity (kg)	Speed (m/s)	Opening Type	Car Inside A x B (mm)	Opening W x H (mm)	Hoistway X x Y (mm)	Pit Depth P (mm)	Overhead OH (mm)	Pit reaction (kN)					
								Rc	Rw	R1	R2	R3	R4
450	1.0	2SL	1000x1200	800x2100	1600x1750	1350	CPH+1400	149	74	42	42	56	40
	1.5					1400	CPH+1500						
	1.75					1450	CPH+1600						
	2.0					1550	CPH+1700						
630	1.0	2CO	1100x1400	800x2100	1850x1700	1350	CPH+1400	156	79	46	46	63	44
	1.5					1400	CPH+1500						
	1.75					1450	CPH+1600						
	2.0					1550	CPH+1700						
800	1.0	2CO	1350x1400	800x2100	2000x1700	1350	CPH+1400	163	83	52	52	69	48
	1.5		1100x1800		1850x2100	1400	CPH+1500						
	1.75					1450	CPH+1600						
	2.0					1550	CPH+1700						
1000	1.0	2CO	1600x1400	900x2100	2200x1700	1350	CPH+1400	167	86	55	55	75	52
	1.5		1400x1600		2100x1900	1400	CPH+1500						
	1.75					1450	CPH+1600						
	2.0					1550	CPH+1700						
1050	1.0	2CO	1600x1500	900x2100	2200x1800	1350	CPH+1400	170	88	55	55	75	52
	1.5		1500x1600		2150x1900	1400	CPH+1500						
	1.75		1100x2100		1950x2400	1450	CPH+1600						
	2.0					1550	CPH+1700						

Note: Car Panel Height (CPH) = Clear Ceiling Height + Suspended Ceiling Height (SCH)
 (For CE-g1, CE-g5, CE-e2 SCH=0mm, For CE-c1, CE-c7 SCH=150mm, For CE-e4 SCH=100mm).
 The standard car panel height is 2350mm.

Power Supply Data

Capacity (kg)	Speed (m/s)	Motor Power (kW)	Rated Current (A)	Acceleration Current (A)	Equivalent Current (A)	Power Capacity (KVA)	Open-Circuit Current (A)	Allowable Maximum Length of Main Power Feeder Line (m)							
								25mm ²	35mm ²	50mm ²	70mm ²	95mm ²	120mm ²	150mm ²	185mm ²
450	1.0	5.2	11	18	4	7	16	585	798	1046	1417	1830	2569	3083	3616
	1.5	7.8	16	27	5	10	20	415	566	741	1005	1298	1822	2186	2564
	1.75	9.0	17	30	5	11	20	384	523	686	929	1200	1685	2022	2371
	2.0	10.4	19	35	6	13	20	339	463	606	821	1061	1489	1787	2096
630	1.0	5.2	15	23	4	7	20	432	589	771	1045	1350	1895	2274	2667
	1.5	7.8	21	36	6	10	25	301	410	537	728	940	1320	1584	1858
	1.75	9.0	23	40	7	11	25	277	377	494	670	866	1215	1458	1710
800	1.0	5.2	19	29	5	7	20	341	465	610	826	1067	1498	1798	2108
	1.5	7.8	27	45	7	10	32	235	321	421	570	736	1034	1240	1455
	1.75	9.0	30	50	8	11	32	216	295	386	523	676	948	1138	1335
1000	1.0	6.5	23	33	6	9	25	281	383	502	680	878	1233	1480	1735
	1.5	9.7	32	50	8	12	40	198	270	354	480	620	870	1044	1225
	1.75	11.4	35	55	9	14	40	182	249	326	442	571	802	962	1129
1050	1.0	13.0	39	64	11	16	40	162	221	290	393	507	712	854	1002
	1.5	6.5	24	35	6	9	25	266	363	476	645	834	1170	1404	1647
	1.75	9.7	34	52	9	12	40	188	256	336	455	588	826	991	1162
1050	1.75	11.4	37	58	10	14	40	173	236	309	419	542	761	913	1071
	2.0	13.0	42	67	12	16	50	154	210	275	372	481	675	810	951

Notes: 1. The data shown above may vary based on elevator specification arrangement.
 2. Earthing wires shall be arranged and installed based on local elevator code requirement.

*1. The above dimensions are for reference only. The actual engineering design data shall be used.
 *2. The above dimensions are based on RC-structure hoistway.
 *3. The above hoistway's internal dimensions are based on the hoistway with waterproof finish.
 *4. If hoistway's internal dimensions are too large, intermediate beams shall be provided and installed by others based on Fujitec-submitted drawings.
 *5. The required thickness of the hoistway's structural walls is 150mm or more (not including the thickness of wall finish).

Work Done by Others

1. Elevator Hoistway Environment

Hoistway Temperature	Hoistway temperature shall be kept from 5 °C (41 °F) to 40 °C (104 °F).
Relative Humidity	<ol style="list-style-type: none"> When a temperature reaches at 40 °C (104 °F), the relative humidity does not go beyond 50%. In the year's most humid month(s), relative humidity shall be kept lower than 90 % and the temperature lower than 25°C (77 °F). Dew condensation prevention measures shall be taken, if there are the possibilities that condensation form inside and on electrical equipment.

2. Electric Power Source

Type of Power Supply	<ol style="list-style-type: none"> Three-Phase Power Supply for Elevator Driving Machine Single-Phase Power Supply for Lighting Equipment
Allowable Error of Voltage Value	The allowable error of voltage value is 7 % above and below the rated voltage.

3. Acceptable Inclination of Hoistway's Vertical Centerline

Hoistway's Vertical Length	Centerline's Tilt away from the Plumb Line (unit: mm)
30 meter or less	0 to 25 mm or less
more than 30 m up to 60 m or less	0 to 35 mm or less
more than 60 m	0 to 50 mm or less

4. Work done by Others

The following items are in the scope of other contractors' work, not covering all items done by them.

1.	Construct solid-state, fire-proof elevator hoistway.
2.	Cut out landing walls for Fujitec's installation of elevator operating fixtures and elevator equipment.
3.	Do wall finishing work by filling cement between jambs and landing walls.
4.	Do wall finishing work by filling cement between landing fixtures and landing walls.
5.	Give water-proofing and drainage treatment in elevator pit including the installation of pumping equipment.
6.	Install space divider screens between respective elevators in a hoistway pit.
7.	Install steel separator beams at regular vertical intervals in a hoistway.
8.	When hoistway is constructed with bricks, put steel lintels in its walls for Fujitec's installation of rail brackets. The steel lintels must be completely fixed inside the walls. The vertical height of the lintel is required to be 300 mm or more. For details, see the relevant drawings.

9.	When an elevator traveling distance from a floor to the next is more than 11 m, make an opening on the hoistway wall between the floors and install emergency exit doors in the opening for passenger evacuation.
10.	It is advised that there is no human access to the space below the hoistway pit.
11.	When the bottom of a hoistway pit is deeper than the required level, add backfill concrete up to the required level.
12.	Provide and install a pit ladder based on the layout drawings.
13.	Provide and install a power switching / distributing board in the hoistway.
14.	Provide and install electrical pipes, wires, and leads in the hoistway. They shall be extended from the power switching / distributing board to the controller, machine, and their related apparatuses.
15.	Provide and install all of electricity supply apparatuses (inclusive of pipes, leads, wires, etc.) on various routes from the building's electricity supply system to the hoistway, landing floors and Fujitec-designated locations.
16.	Install air ventilator(s) and/or air conditioner(s) in order to keep the hoistway temperature between 5 °C (41 °F) and 40 °C (104 °F).
17.	Provide and install electrical outlets inside the hoistway.
18.	Install lighting equipment of 30 watt or more at 7-meter intervals inside the hoistway with 0.5-meter clearance at the top and bottom of the hoistway. The lighting intensity is required to be 50 lux or more at the car-top working platform and at the 1-meter high position above the pit bottom.
19.	Make holes in the walls of a hoistway for Fujitec's installation of machine support beams and fill concrete into the gap between the walls and the fixed beams.
20.	Cut out landing walls and install emergency operation panels for Fujitec's emergency access to and operation of elevator machine and brake.
21.	Install machine lifting hooks and / or beams on the hoistway's ceiling slabs. The required lifting load capability is stated on the relevant installation drawings.

	Ground-fault circuit interrupter and current leakage alarm are required to be protected against current-harmonic distortion.
	Lay building's telecommunication lines 500 mm away from the electric feeder lines for elevator system.
	Remove corroded metal materials from the hoistway.
	Protect the hoistway against hazardous gas.
	Prevent dust from accumulating in the hoistway.
	Provide a storage room in order to stock elevator parts and installation materials.
	Do not place any tools and materials not related to elevators in the hoistway.

FUJITEC
www.fujitec.com

REXIA-H

Machine-Room-Less Elevator